

### Portable ultrasonic flow measurement of gas and liquids in hazardous areas

Portable instrument for non-invasive, quick ultrasonic flow measurement with clamp-on technology for all types of piping

#### Features

- Precise bidirectional and highly dynamic flow measurement with the non-invasive clamp-on technology
- High precision at fast and slow flow rates, high temperature and zero point stability
- Portable, easy-to-use flow transmitter with 2 flow channels, multiple inputs/outputs, an integrated data logger with a serial interface
- Extremely resistant carbon fiber housing
- Covered by ATEX/IECEX zone 2 certification
- Compact and very lightweight, allowing the measuring system to be easily carried as personal luggage, e.g. for offshore visits
- Water tight; resistant against oil, many liquids and dirt
- Li-Ion battery provides up to 25 hours of measurement operation
- Automatic loading of calibration data and transducer detection for a fast and easy set-up (less than 5 min), providing precise and long-term stable results
- User-friendly design
- Transducers available for a wide range of inner pipe diameters and fluid temperatures
- Rugged transducers (ATEX/IECEX zone 1 and 2, resistant to rough environments, dust and humidity)
- Robust, water-tight (IP67) transport case with comprehensive accessories
- QuickFix for fast mounting of the flow transmitter in difficult conditions
- Including measurement of liquids

#### Applications

Designed for the following industries:

- Upstream (on- and offshore)
- Midstream and downstream (pipelines and refineries)
- Chemical industry
- Energy sector (e.g. HVAC, geothermal, power plants)



FLUXUS G608



Measurement with transducers mounted with the portable Variofix VP



Measurement with the flow transmitter fixed to the pipe with the QuickFix pipe mounting fixture

<b>Function</b> .....	3
Measurement principle .....	3
Calculation of volumetric flow rate .....	3
Number of sound paths .....	4
Typical measurement setup .....	5
Standard volumetric flow rate .....	6
<b>Transmitter</b> .....	7
Technical data .....	7
Dimensions .....	9
Standard scope of supply .....	9
Adapters .....	10
<b>Transducers</b> .....	13
Transducer selection .....	13
Transducer order code .....	16
Technical data .....	17
<b>Transducer mounting fixture</b> .....	23
<b>Coupling materials for transducers</b> .....	24
<b>Damping material (optional)</b> .....	25
Damping mats .....	25
Damping coat .....	26
<b>Connection systems</b> .....	27
<b>Clamp-on temperature probe (optional)</b> .....	28
Technical data .....	28
Fixation .....	29
<b>Wall thickness measurement (optional)</b> .....	30
Technical data .....	30

## Function

### Measurement principle

The transducers are mounted on the pipe which is completely filled with the fluid. The ultrasonic signals are emitted alternately by a transducer and received by the other. The physical quantities are determined from the transit times of the ultrasonic signals.

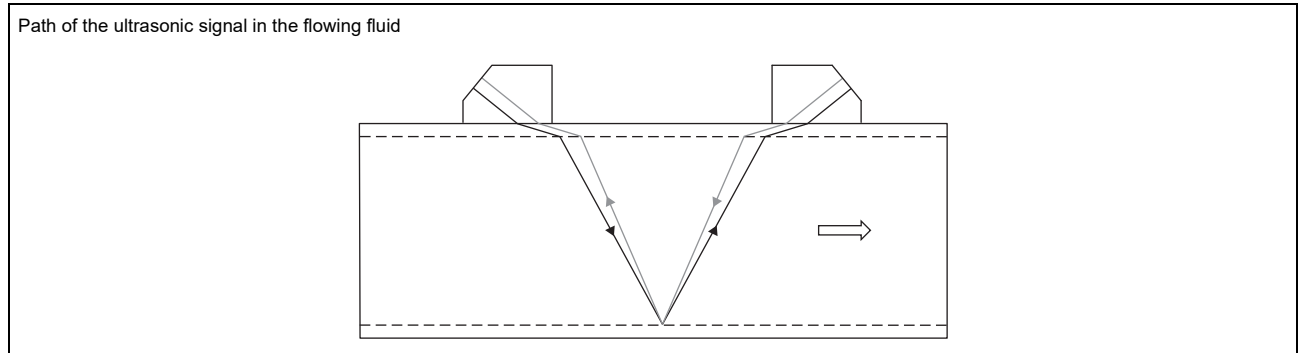

As the fluid where the ultrasound propagates is flowing, the transit time of the ultrasonic signal in flow direction is shorter than the one against the flow direction.

The transit time difference  $\Delta t$  is measured and allows the flowmeter to determine the average flow velocity along the propagation path of the ultrasonic signals. A flow profile correction is then performed in order to obtain the area averaged flow velocity, which is proportional to the volumetric flow rate.

The integrated microprocessors control the entire measuring cycle. The received ultrasonic signals are checked for measurement usability and evaluated for their reliability. Noise signals are eliminated.

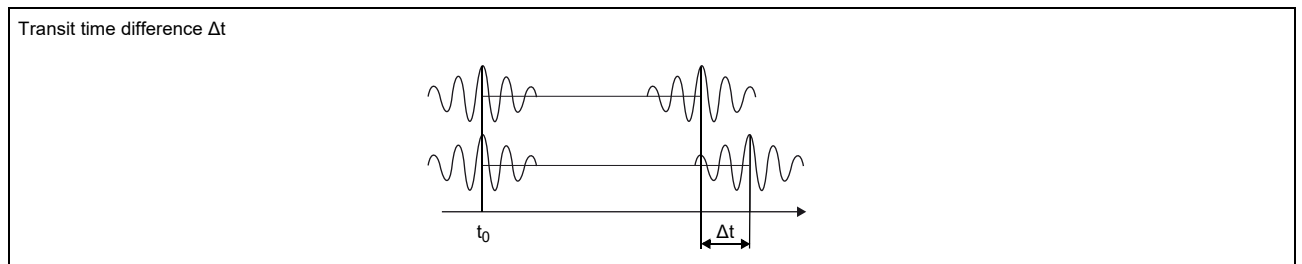

### Calculation of volumetric flow rate

$$\dot{V} = k_{Re} \cdot A \cdot k_a \cdot \frac{\Delta t}{2 \cdot t_y}$$

where

- $\dot{V}$  - volumetric flow rate
- $k_{Re}$  - fluid mechanics calibration factor
- $A$  - cross-sectional pipe area
- $k_a$  - acoustical calibration factor
- $\Delta t$  - transit time difference
- $t_y$  - average of transit times in the fluid

### Number of sound paths

The number of sound paths is the number of transits of the ultrasonic signal through the fluid in the pipe. Depending on the number of sound paths, the following methods of installation exist:

- **reflection arrangement**

The number of sound paths is even. The transducers are mounted on the same side of the pipe. Correct positioning of the transducers is easier.

- **diagonal arrangement**

The number of sound paths is odd. The transducers are mounted on opposite sides of the pipe. In the case of a high signal attenuation by the fluid, pipe and coatings, diagonal arrangement with 1 sound path will be used.

The preferred method of installation depends on the application. While increasing the number of sound paths increases the accuracy of the measurement, signal attenuation increases as well. The optimum number of sound paths for the parameters of the application will be determined automatically by the transmitter.

As the transducers can be mounted with the transducer mounting fixture in reflection arrangement or diagonal arrangement, the number of sound paths can be adjusted optimally for the application.

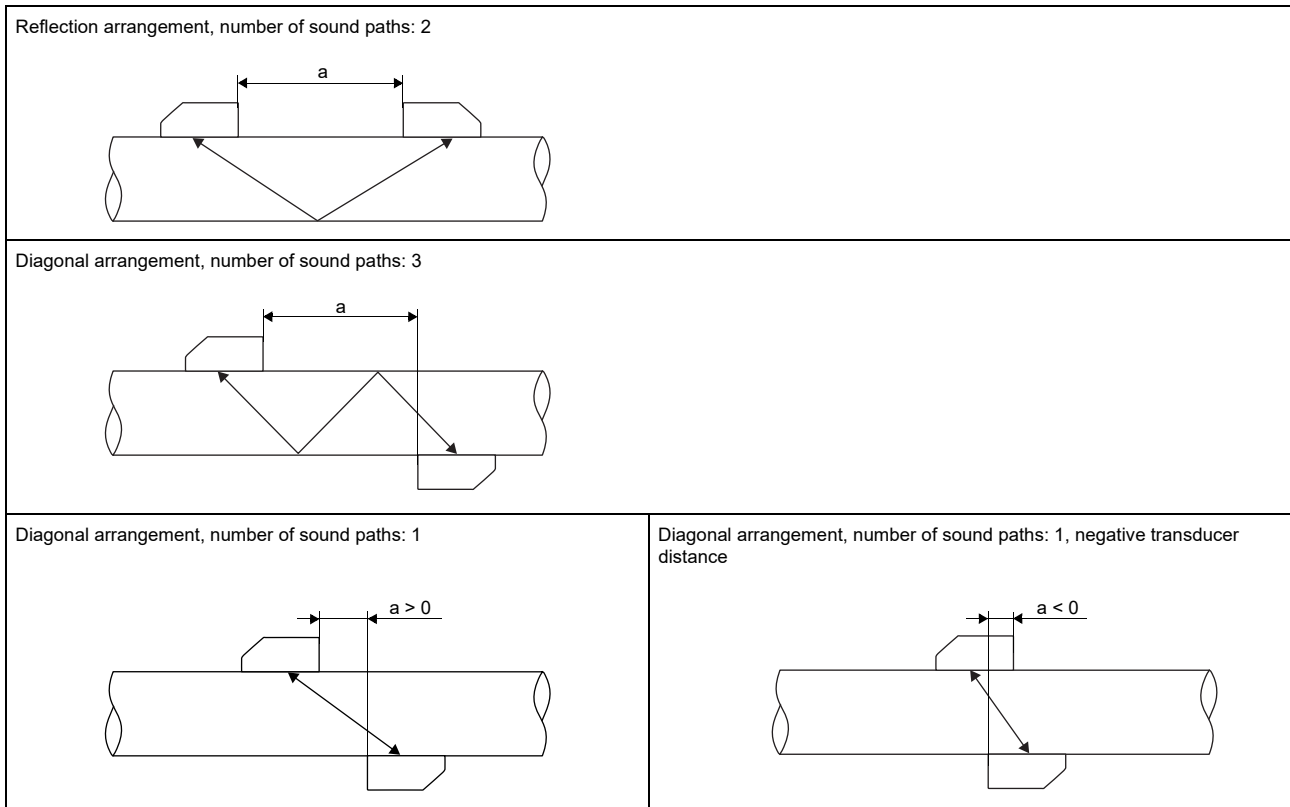

a - transducer distance

### Typical measurement setup

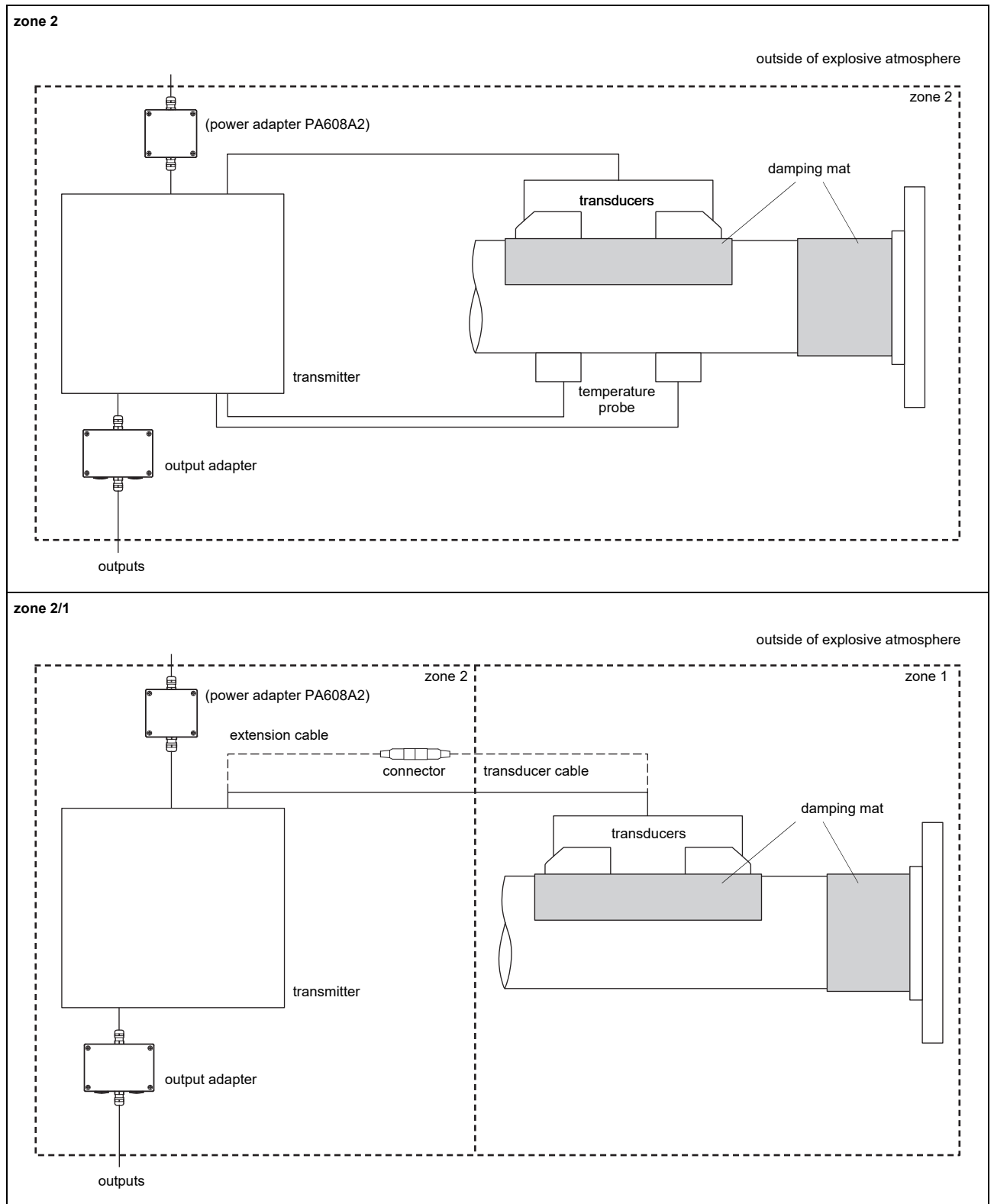

## Standard volumetric flow rate

The standard volumetric flow rate can be selected as physical quantity to be measured. It will be calculated internally by:

$$\dot{V}_N = \dot{V} \cdot \frac{p}{p_N} \cdot \frac{T_N}{T} \cdot \frac{1}{K}$$

where

- $\dot{V}_N$  - standard volumetric flow rate
- $\dot{V}$  - operating volumetric flow rate
- $p_N$  - standard pressure (absolute value)
- $p$  - operating pressure (absolute value)
- $T_N$  - standard temperature in K
- $T$  - operating temperature in K
- $K$  - compressibility coefficient of the gas: ratio of the compressibility factors of the gas at operating conditions and at standard conditions  $Z/Z_N$

The operational pressure  $p$  and the operational temperature  $T$  of the fluid will be entered directly as fixed values into the transmitter. If temperature inputs are installed (optional), the temperature can be measured by the customer and fed in the transmitter.

The gas compressibility coefficient  $K$  of the gas is entered in the transmitter:

- as fixed value or
- as approximation according to e.g. AGA8 or GERG

# Transmitter

## Technical data

<b>FLUXUS G608**-A2</b>	
	
design	portable, zone 2
<b>measurement</b>	
measurement principle	transit time difference correlation principle
flow velocity	m/s 0.01...35 m/s, depending on pipe diameter
repeatability	0.15 % of reading ±0.005 m/s
fluid	all acoustically conductive gases, e.g. nitrogen, air, oxygen, hydrogen, argon, helium, ethylene, propane
temperature compensation	corresponding to the recommendations in ANSI/ASME MFC-5.1-2011
<b>measurement uncertainty (volumetric flow rate)</b>	
measurement uncertainty of measuring system <sup>1</sup>	±0.3 % of reading ±0.005 m/s
measurement uncertainty at the measuring point	±1...3 % of reading ±0.005 m/s, depending on application
<b>transmitter</b>	
power supply	<ul style="list-style-type: none"> <li>• 100...230 V/50...60 Hz (power supply unit, outside of explosive atmosphere)</li> <li>• 10.5...15 V DC (socket at transmitter, with power adapter PA608A2 (optional) and power connection adapter PA608NN (optional))</li> <li>• integrated battery</li> </ul>
integrated battery	Li-Ion, 7.2 V/6.2 Ah
operating time	<ul style="list-style-type: none"> <li>• &gt; 14 h (without outputs, inputs and backlight)</li> <li>• &gt; 25 h (1 measuring channel, ambient temperature &gt; 10 °C, without outputs, inputs and backlight)</li> </ul>
power consumption	W < 6 (with outputs, inputs and backlight), charging: 18
number of measuring channels	2
damping	s 0...100 (adjustable)
measuring cycle	Hz 100...1000 (1 channel)
response time	s 1 (1 channel), option: 0.07
housing material	PA, TPS, PC, Polyester, stainless steel
degree of protection	IP65
dimensions	mm see dimensional drawing
weight	kg 2.2
fixation	QuickFix pipe mounting fixture
ambient temperature	°C -10...+60
display	2 x 16 characters, dot matrix, backlight
menu language	English, German, French, Dutch, Spanish
<b>explosion protection</b>	
<b>• ATEX/IECEX</b>	
marking	<p>CE 0637 Ex II 3G II 2D                  Ex nA nC ic [ic] IIC (T6)T4 Gc                  T<sub>a</sub> -10...+(50)60 °C                  Ex tb IIIC T100 °C Db</p>
certification ATEX	IBExU10ATEX1067
certification IECEX	IECEX IBE 12.0006
intrinsic safety parameters	U <sub>m</sub> = 16 V DC intrinsically safe inputs: U <sub>o</sub> = 22 V, I <sub>o</sub> = 6 mA, P <sub>o</sub> = 33 mW, C <sub>o</sub> = 450 nF, L <sub>o</sub> = 10 mH C <sub>i</sub> = 1.8 nF, L <sub>i</sub> = 10 μH
<b>measuring functions</b>	
physical quantities	operating volumetric flow rate, standard volumetric flow rate, mass flow rate, flow velocity
totalizer	volume, mass
calculation functions	average, difference, sum
diagnostic functions	sound speed, signal amplitude, SNR, SCNR, standard deviation of amplitudes and transit times
<b>communication interfaces</b>	
service interfaces	<ul style="list-style-type: none"> <li>• RS232</li> <li>• USB (with adapter)</li> </ul>

<sup>1</sup> with aperture calibration of the transducers

For the technical data in the flow measurement of liquids mode see Technical specification TSFLUXUS\_F608xx-A2V\*-\*.

FLUXUS G608**-A2	
<b>accessories</b>	
serial data kit	
• cable	RS232
• adapter	RS232 - USB
software	<ul style="list-style-type: none"> <li>FluxDiagReader: download of measured values and parameters, graphical presentation</li> <li>FluxDiag (optional): download of measurement data, graphical presentation, report generation</li> <li>FluxSubstanceLoader: upload of fluid data sets</li> </ul>
adapter	<ul style="list-style-type: none"> <li>output adapter (necessary, option)</li> <li>input adapter (if number of inputs &gt; 2)</li> </ul>
transport case	dimensions: 500 x 400 x 190 mm
<b>data logger</b>	
loggable values	all physical quantities, totalized values and diagnostic values
capacity	> 100 000 measured values
<b>outputs</b>	
	The outputs are galvanically isolated from the transmitter.
number	analog outputs: max. 4 <ul style="list-style-type: none"> <li>0, 2 or 4 active current outputs or passive current outputs or frequency outputs or</li> <li>2 active current outputs and 2 passive current outputs or</li> <li>2 active current outputs and 2 frequency outputs or</li> <li>2 passive current outputs and 2 frequency outputs</li> </ul> binary outputs: max. 4
<b>• current output</b>	
range	mA 0/4...20
accuracy	0.1 % of reading $\pm 15 \mu\text{A}$
active output	$R_{\text{ext}} < 200 \Omega$
passive output	$U_{\text{ext}} = 4...9 \text{ V}$ , depending on $R_{\text{ext}}$ ( $R_{\text{ext}} < 200 \Omega$ at 9 V)
<b>• frequency output</b>	
range	kHz 0...5
open collector	24 V/4 mA
<b>• binary output</b>	
optorelay	26 V/100 mA
binary output as alarm output	
• functions	limit, change of flow direction or error
binary output as pulse output	
• functions	mainly for totalizing
• pulse value	units 0.01...1000
• pulse width	ms 1...1000
<b>inputs</b>	
	The inputs are galvanically isolated from the transmitter.
number	max. 4
<b>• temperature input</b>	
	intrinsic safety
type	Pt100/Pt1000
connection	4-wire
range	$^{\circ}\text{C}$ -150...+560
resolution	K 0.01
accuracy	$\pm 0.01 \%$ of reading $\pm 0.03 \text{ K}$

<sup>1</sup> with aperture calibration of the transducers

For the technical data in the flow measurement of liquids mode see Technical specification TSFLUXUS\_F608xx-A2V\*.\*.



## Dimensions

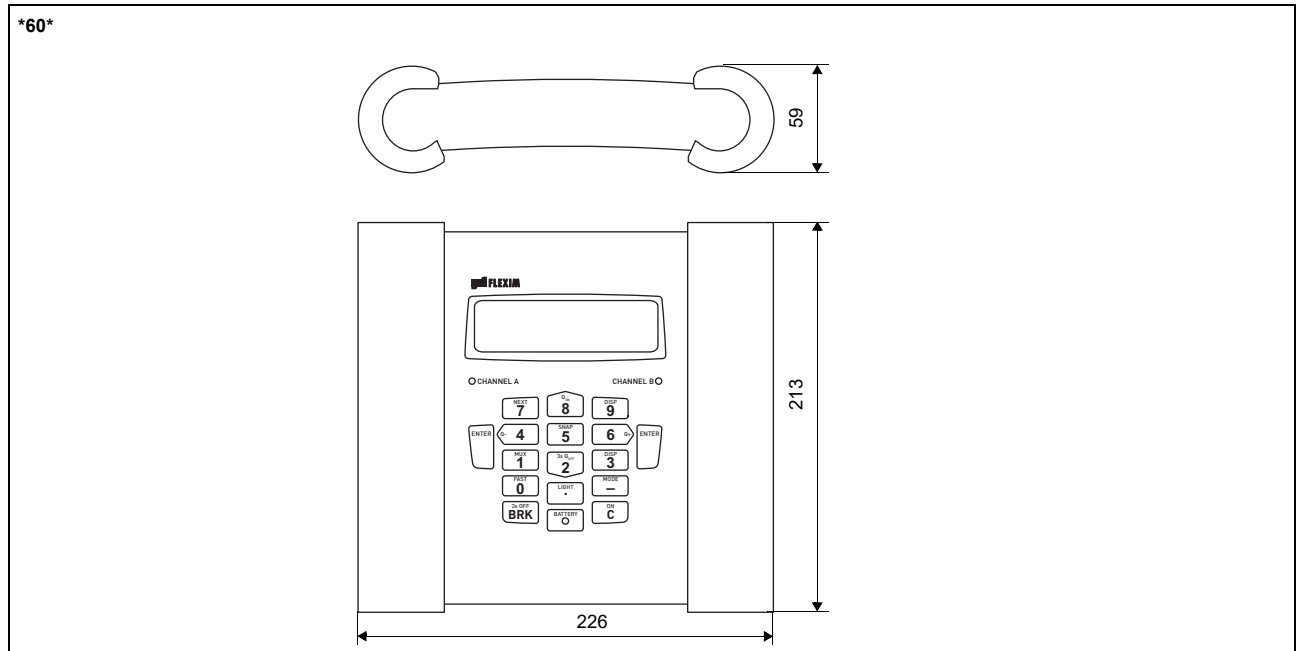

in mm

## Standard scope of supply

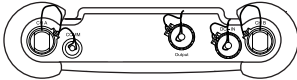
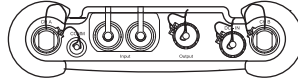
	G608 Standard	G608 CA-Energy
application	flow measurement of gas	flow measurement of compressed air, industrial gases and liquids
	2 independent measuring channels	
	calculation of standard volumetric flow rate	calculation of standard volumetric flow rate, with optional use of current measured temperature values
		liquids: integrated heat flow computer for monitoring of energy flows
<b>outputs</b>		
passive current output	2	2
binary output	2	2
<b>inputs</b>		
temperature input	-	4
<b>accessories</b>		
transport case	x	x
power supply unit, mains cable	x	x
battery	x	x
power adapter PA608A2 <sup>1</sup>	-	-
power connection adapter PA608NN <sup>1</sup>	-	-
output adapter <sup>1</sup>	-	-
input adapter	-	2
QuickFix pipe mounting fixture for transmitter	x	x
serial data kit	x	x
measuring tape	x	x
wall thickness probe	-	x
user manual, safety instructions, Quick start guide	x	x
connector board at the upper side of the transmitter		

<sup>1</sup> if required, to be ordered separately

### Adapters

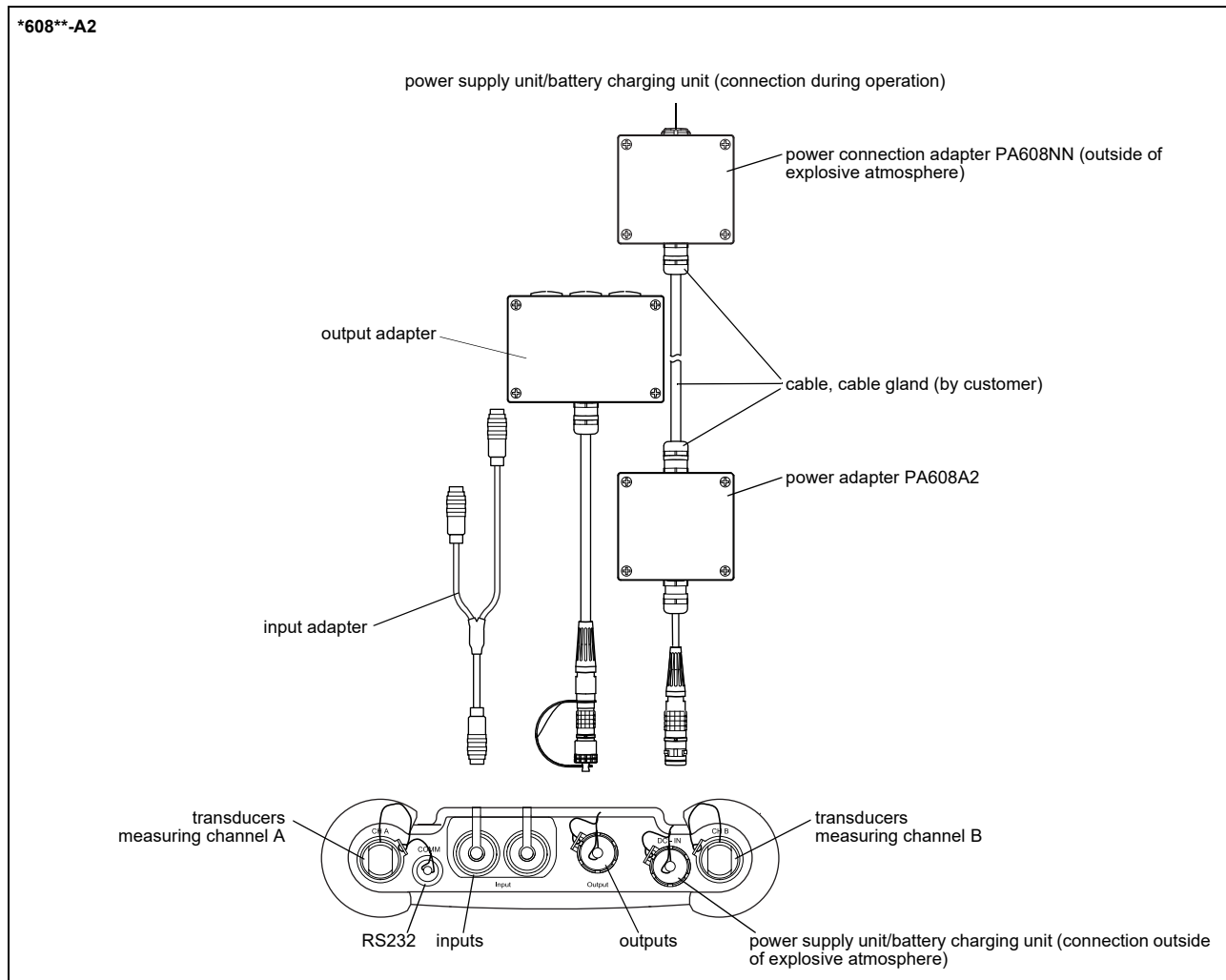

### Technical data

	output adapter	power adapter	power connection adapter
technical type	OA608A2	PA608A2	PA608NN
connection voltage		10.5...15 V DC	
weight	kg 0.26	0.26	0.32
<b>material</b>			
housing	polyester		polyester
gasket	silicone		chloroprene
degree of protection	IP66		IP65
<b>ambient temperature</b>			
min.	°C -20		-10
max.	°C +90		+60
<b>explosion protection</b>			
• ATEX			
marking	CE Ex II3G Ex nA IIC T6 Gc Ta -10...+60 °C		-

**Dimensions**

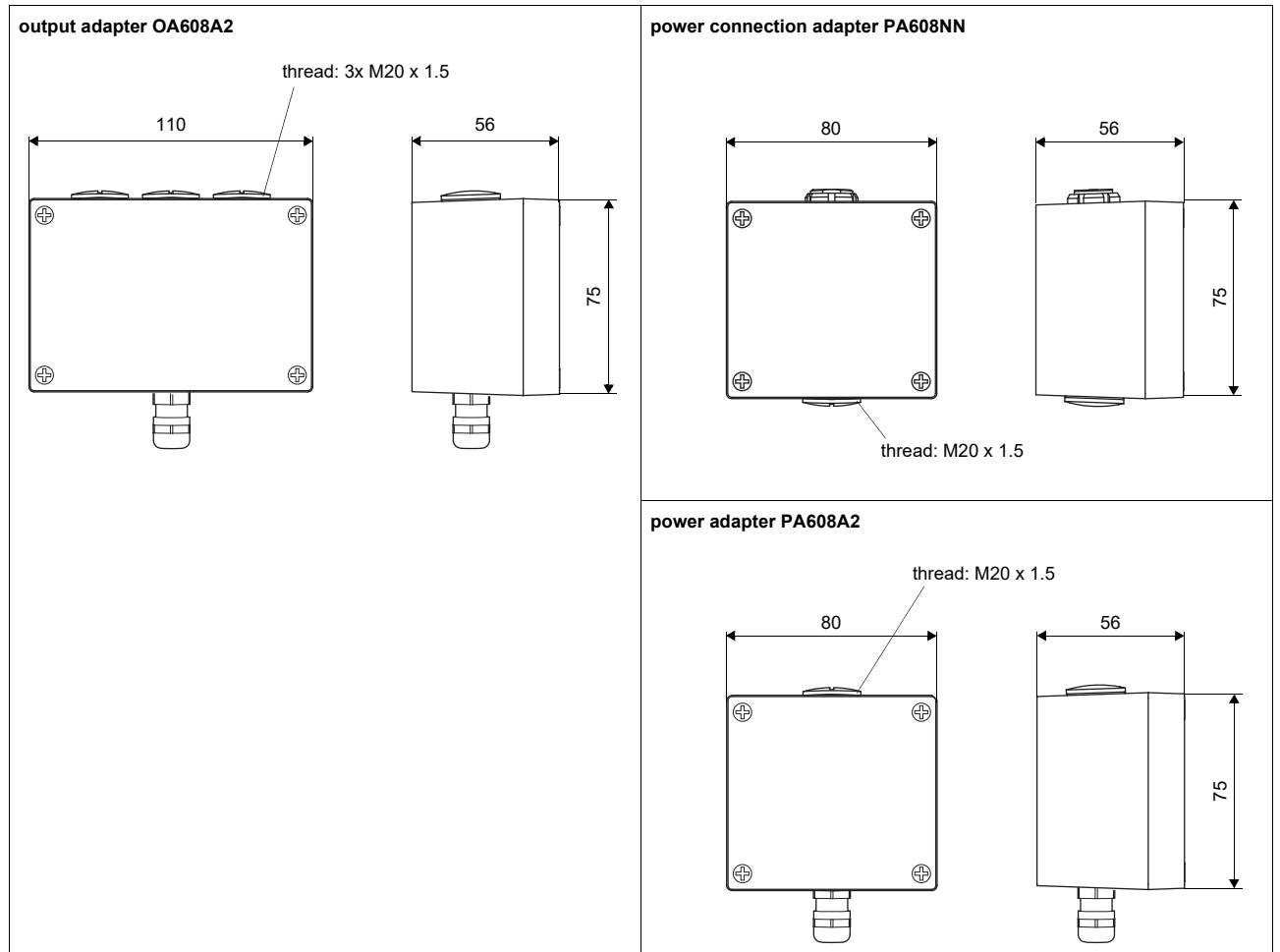

in mm

### Terminal assignment

output adapter OA608A2

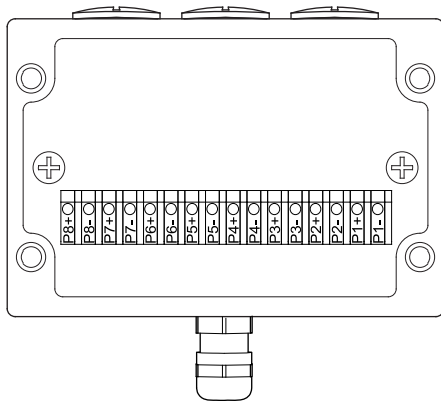

power connection adapter PA608NN<sup>1</sup>

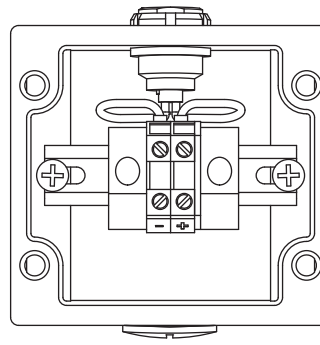

power adapter PA608A2<sup>1</sup>

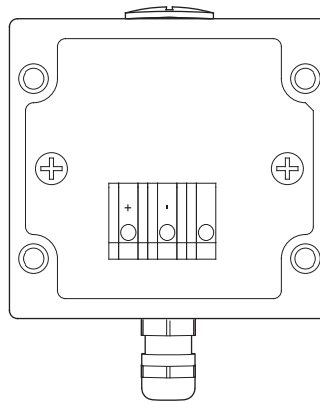

<sup>1</sup> cable PA608A2 - PA608NN (by customer):  
length: max. 30 m  
lead cross sectional area: 1.5...2.5 mm<sup>2</sup>

## Transducers

### Transducer selection

#### Step 1a

Select a Lamb wave transducer:

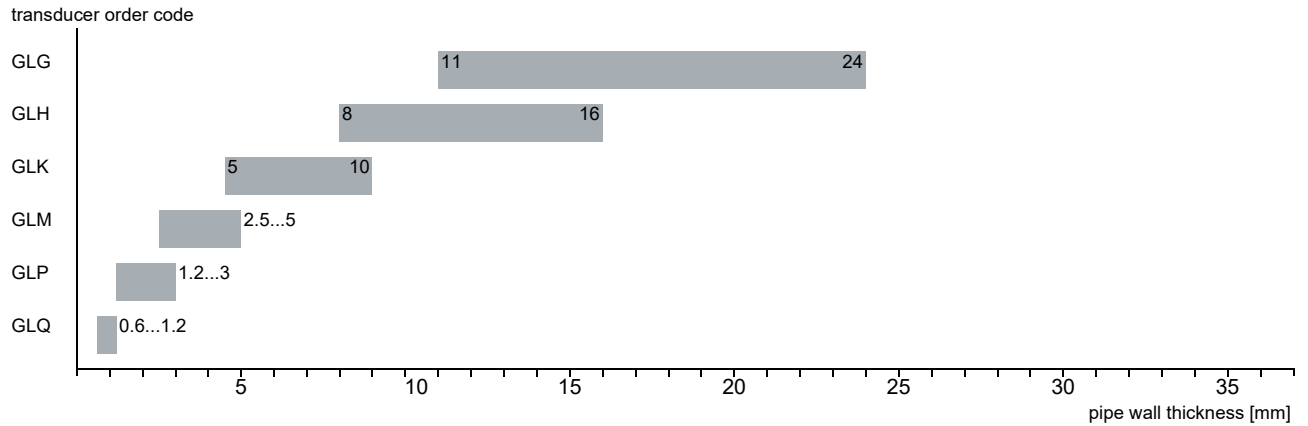

#### Step 1b

If the pipe wall thickness is not in the range of the Lamb wave transducers, select a shear wave transducer:

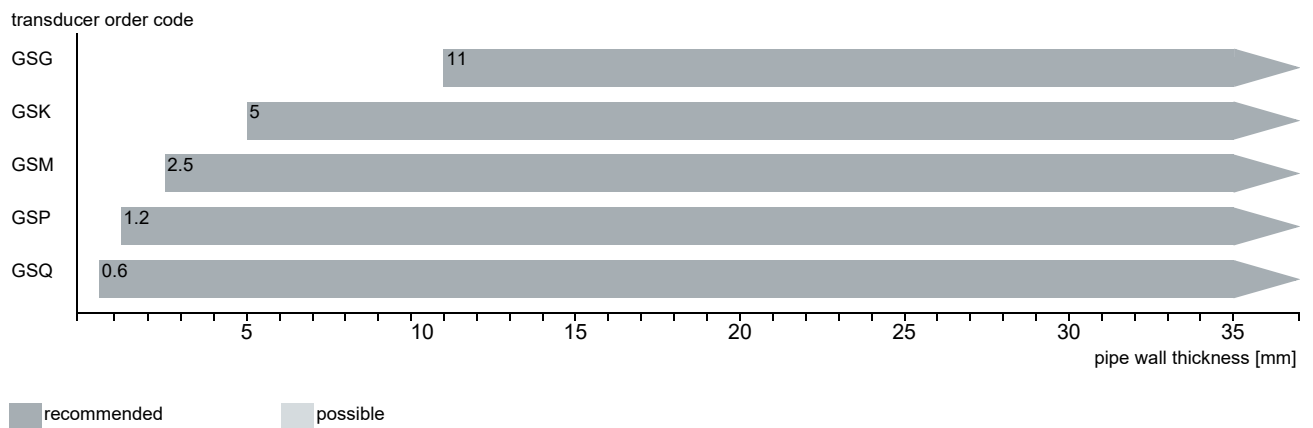

#### Step 2

inner pipe diameter  $d$  dependent on the flow velocity  $v$  of the fluid in the pipe

The transducers are selected from the characteristics (see next page). Lamb wave transducers are selected from the left column, shear wave transducers from the right column.

Lamb wave transducers: If the values  $d$  and  $v$  are not in the range, the diagonal arrangement with 1 sound path may be used, i.e. the same characteristics can be used with doubling the inner pipe diameter. If the values are still not in the range, shear waves transducers regarding the pipe wall thickness have to be selected in step 1b.

**Lamb wave transducer<sup>1</sup>**

**shear wave transducer<sup>1</sup>**

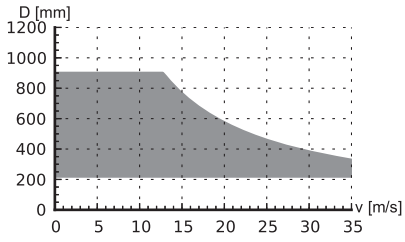

GLG

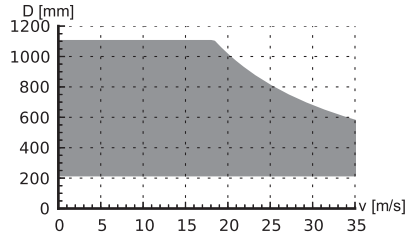

GSG

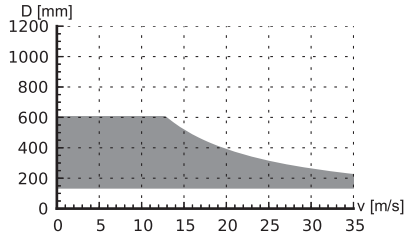

GLH

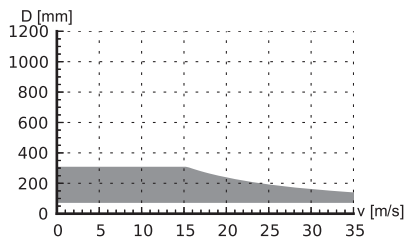

GLK

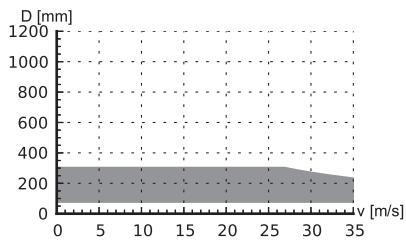

GSK

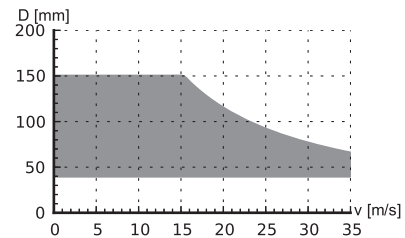

GLM

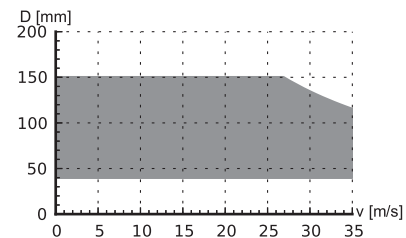

GSM

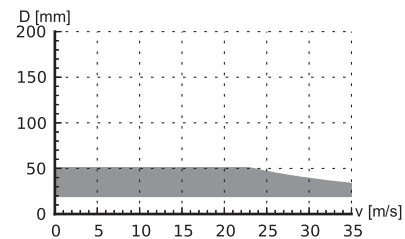

GLP

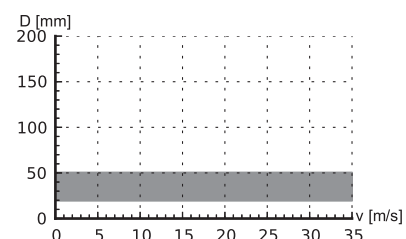

GSP

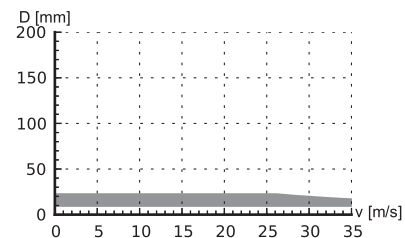

GLQ

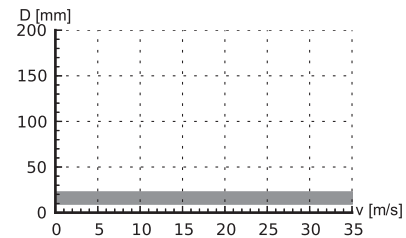

GSQ

<sup>1</sup> inner pipe diameter and max. flow velocity for a typical application with natural gas, nitrogen, oxygen in reflection arrangement with 2 sound paths (Lamb wave transducers)/1 sound path (shear wave transducers)

### Step 3

min. fluid pressure

Lamb wave transducer			
transducer or- der code	fluid pressure <sup>1</sup> [bar]		
	metal pipe	plastic pipe	
	min.	min. extended	min.
GLG	15	10	1
GLH	15	10	1
GLK	15 (d > 120 mm) 10 (d < 120 mm)	10 (d > 120 mm) 3 (d < 120 mm)	1
GLM	10 (d > 60 mm) 5 (d < 60 mm)	3 (d < 60 mm)	1
GLP	10 (d > 35 mm) 5 (d < 35 mm)	3 (d < 35 mm)	1
GLQ	10 (d > 15 mm) 5 (d < 15 mm)	3 (d < 15 mm)	1

shear wave transducer			
transducer or- der code	fluid pressure <sup>1</sup> [bar]		
	metal pipe	plastic pipe	
	min.	min. extended	min.
GSG	30	20	1
GSK	30	20	1
GSM	30	20	1
GSP	30	20	1
GSQ	30	20	1

<sup>1</sup> depending on application, typical absolute value for natural gas, nitrogen, compressed air

d - inner pipe diameter

### Example

step					
1	pipe wall thickness	mm	14.3	8.6	38
	selected transducer		GLG or GLH	GLH or GLK	GS
2	inner pipe diameter	mm	581	96.8	143
	max. flow velocity	m/s	15	30	30
	selected transducer		GLG	GLK	GSK
3	min. fluid pressure	bar	20	15	40
	selected transducer		GLG	GLK	GSK

### Step 4

for the characters 4...11 of the transducer order code (ambient temperature, explosion protection, connection system, extension cable) see page 16

### Step 5

for the technical data of the selected transducer see page 17 et seqq.

### Transducer order code

1, 2	3	4	5, 6	7, 8	9...11	no. of character				
transducer	transducer frequency	-	ambient temperature	explosion protection	connection system	-	extension cable	/	option	description
GS										set of ultrasonic flow transducers for gas measurement, shear wave
GL										set of ultrasonic flow transducers for gas measurement, Lamb wave
	G									0.2 MHz
	H									0.3 MHz
	K									0.5 MHz
	M									1 MHz
	P									2 MHz
	Q									4 MHz
		N								normal temperature range
		E								extended temperature range
			A2							ATEX zone 2/IECEx zone 2
			A1							ATEX zone 1/IECEx zone 1
				NL						with Lemo connector
							XXX			0 m: without extension cable > 0 m: with extension cable (connector outside of ATEX zone 1/IECEx zone 1)
								LC		long transducer cable



## Technical data

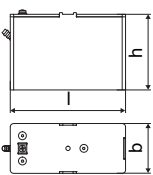
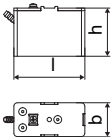
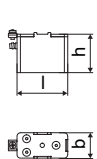

### Shear wave transducers (zone 2, NL)

order code		GSG-N*2NL/**	GSK-N*2NL/**	GSM-N*2NL/**	GSP-N*2NL/**	GSQ-N*2NL/**
technical type		G(DL)G1NH1	G(DL)K1NH1	G(DL)M2NH1	G(DL)P2NH1	G(DL)Q2NH1
transducer frequency	MHz	0.2	0.5	1	2	4
<b>fluid pressure<sup>1</sup></b>						
min. extended	bar	metal pipe: 20				
min.	bar	metal pipe: 30, plastic pipe: 1				
<b>inner pipe diameter d<sup>2</sup></b>						
min. extended	mm	180	60	30	15	7
min. recommended	mm	220	80	40	20	10
max. recommended	mm	900	300	150	50	22
max. extended	mm	1100	360	180	60	30
<b>pipe wall thickness</b>						
min.	mm	11	5	2.5	1.2	0.6
<b>material</b>						
housing		PEEK with stainless steel cap and transducer shoe 304 (1.4301)				
contact surface		PEEK				
degree of protection		IP65	IP66			IP65
<b>transducer cable</b>						
type		1699				
length	m	5		4		3
length (**-*****/LC)	m	9				
<b>dimensions</b>						
length l	mm	136.5		84		70
width b	mm	59		40		30
height h	mm	90.5		59		47.5
dimensional drawing						
weight (without cable)	kg	1.674		0.504		0.251
<b>pipe surface temperature</b>						
min.	°C	-40				
max.	°C	+130				
<b>ambient temperature</b>						
min.	°C	-40				
max.	°C	+130				
temperature compensation		x				
<b>explosion protection</b>						
<b>• ATEX/IECEX</b>						
order code		GSG-NA2NL/**	GSK-NA2NL/**	GSM-NA2NL/**	GSP-NA2NL/**	GSQ-NA2NL/**
pipe surface temperature (Ex)						
• min.	°C	-55				
• max.	°C	gas: +190, dust: +180				
marking		CE 0637 Ex II3G Ex nA IIC T6...T2 Gc Ex tb IIIC TX Db				
certification ATEX		IBExU10ATEX1163 X				
certification IECEX		IECEX IBE 12.0005X				

<sup>1</sup> depending on application, typical absolute value for natural gas, nitrogen, compressed air

<sup>2</sup> shear wave transducer:  
 typical values for natural gas, nitrogen, oxygen, pipe diameters for other fluids on request  
 inner pipe diameter max. recommended/max. extended: in reflection arrangement and for a flow velocity of 15 m/s

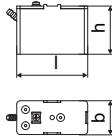
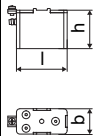
**Shear wave transducers (zone 2, NL, extended temperature range)**

order code		GSM-E*2NL/**	GSP-E*2NL/**	GSQ-E*2NL/**
technical type		G(DL)M2EH5	G(DL)P2EH5	G(DL)Q2EH5
transducer frequency	MHz	1	2	4
<b>fluid pressure<sup>1</sup></b>				
min. extended	bar	metal pipe: 20		
min.	bar	metal pipe: 30, plastic pipe: 1		
<b>inner pipe diameter d<sup>2</sup></b>				
min. extended	mm	30	15	7
min. recommended	mm	40	20	10
max. recommended	mm	150	50	22
max. extended	mm	180	60	30
<b>pipe wall thickness</b>				
min.	mm	2.5	1.2	0.6
<b>material</b>				
housing		PI with stainless steel cap and transducer shoe 304 (1.4301)		
contact surface		PI		
degree of protection		IP66		IP56
<b>transducer cable</b>				
type		6111		
length	m	4		3
length (**-*****/LC)	m	9		
<b>dimensions</b>				
length l	mm	84		70
width b	mm	40		30
height h	mm	59		47.5
dimensional drawing				
weight (without cable)	kg	0.505		0.252
<b>pipe surface temperature</b>				
min.	°C	-30		
max.	°C	+200		
<b>ambient temperature</b>				
min.	°C	-30		
max.	°C	+200		
temperature compensation		x		
<b>explosion protection</b>				
<b>• ATEX/IECEX</b>				
order code		GSM-EA2NL/**	GSP-EA2NL/**	GSQ-EA2NL/**
pipe surface temperature (Ex)				
• min.	°C	-45		
• max.	°C	gas: +235, dust: +225		
marking		CE 0637  II3G II2D Ex nA IIC T6...T2 Gc Ex tb IIIA TX Db		
certification ATEX		IBExU10ATEX1163 X		
certification IECEX		IECEX IBE 12.0005X		

<sup>1</sup> depending on application, typical absolute value for natural gas, nitrogen, compressed air

<sup>2</sup> shear wave transducer:  
 typical values for natural gas, nitrogen, oxygen, pipe diameters for other fluids on request  
 inner pipe diameter max. recommended/max. extended: in reflection arrangement and for a flow velocity of 15 m/s



**Shear wave transducers (zone 1, NL)**

order code		GSG-N*1NL/**	GSK-N*1NL/**	GSM-N*1NL/**	GSP-N*1NL/**	GSQ-N*1NL/**
technical type		G(DL)G1NW1	G(DL)K1NW1	G(DL)M2NW1	G(DL)P2NW1	G(DL)Q2NW1
transducer frequency	MHz	0.2	0.5	1	2	4
<b>fluid pressure<sup>1</sup></b>						
min. extended	bar	metal pipe: 20				
min.	bar	metal pipe: 30, plastic pipe: 1				
<b>inner pipe diameter d<sup>2</sup></b>						
min. extended	mm	180	60	30	15	7
min. recommended	mm	220	80	40	20	10
max. recommended	mm	900	300	150	50	22
max. extended	mm	1100	360	180	60	30
<b>pipe wall thickness</b>						
min.	mm	11	5	2.5	1.2	0.6
<b>material</b>						
housing		PEEK with stainless steel cap and transducer shoe 304 (1.4301)				
contact surface		PEEK				
degree of protection		IP65	IP66			IP65
<b>transducer cable</b>						
type		1699				
length	m	5		4		3
length (***_*****/LC)	m	9				
<b>dimensions</b>						
length l	mm	136.5		84		70
width b	mm	59		40		30
height h	mm	90.5		59		47.5
dimensional drawing						
weight (without cable)	kg	1.674		0.504		0.251
<b>pipe surface temperature</b>						
min.	°C	-40				
max.	°C	+130				
<b>ambient temperature</b>						
min.	°C	-40				
max.	°C	+130				
temperature compensation		x				
<b>explosion protection</b>						
• ATEX/IECEX						
order code		GSG-NA1NL/**	GSK-NA1NL/**	GSM-NA1NL/**	GSP-NA1NL/**	GSQ-NA1NL/**
pipe surface temperature (Ex)						
• min.	°C	-55				
• max.	°C	+180				
marking		CE 0637 Ex II2G II2D Ex q IIC T6...T3 Gb Ex tb IIIC TX Db				
certification ATEX		IBExU07ATEX1168 X				
certification IECEx		IECEx IBE 08.0007X				

<sup>1</sup> depending on application, typical absolute value for natural gas, nitrogen, compressed air

<sup>2</sup> shear wave transducer:  
 typical values for natural gas, nitrogen, oxygen, pipe diameters for other fluids on request  
 inner pipe diameter max. recommended/max. extended: in reflection arrangement and for a flow velocity of 15 m/s

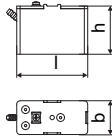
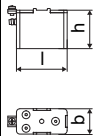
**Shear wave transducers (zone 1, NL, extended temperature range)**

order code		GSM-E*1NL/**	GSP-E*1NL/**	GSQ-E*1NL/**
technical type		G(DL)M2EW5	G(DL)P2EW5	G(DL)Q2EW5
transducer frequency	MHz	1	2	4
<b>fluid pressure<sup>1</sup></b>				
min. extended	bar	metal pipe: 20		
min.	bar	metal pipe: 30, plastic pipe: 1		
<b>inner pipe diameter d<sup>2</sup></b>				
min. extended	mm	30	15	7
min. recommended	mm	40	20	10
max. recommended	mm	150	50	22
max. extended	mm	180	60	30
<b>pipe wall thickness</b>				
min.	mm	2.5	1.2	0.6
<b>material</b>				
housing		PI with stainless steel cap and transducer shoe 304 (1.4301)		
contact surface		PI		
degree of protection		IP66		IP56
<b>transducer cable</b>				
type		6111		
length	m	4		3
length (**-*****/LC)	m	9		
<b>dimensions</b>				
length l	mm	84		70
width b	mm	40		30
height h	mm	59		47.5
dimensional drawing				
weight (without cable)	kg	0.505		0.252
<b>pipe surface temperature</b>				
min.	°C	-30		
max.	°C	+200		
<b>ambient temperature</b>				
min.	°C	-30		
max.	°C	+200		
temperature compensation		x		
<b>explosion protection</b>				
<b>• ATEX/IECEX</b>				
order code		GSM-EA1NL/**	GSP-EA1NL/**	GSQ-EA1NL/**
pipe surface temperature (Ex)				
• min.	°C	-45		
• max.	°C	+225		
marking		CE 0637  II2G II2D Ex q IIC T6...T2 Gb Ex tb IIIA TX Db		
certification ATEX		IBExU07ATEX1168 X		
certification IECEX		IECEX IBE 08.0007X		

<sup>1</sup> depending on application, typical absolute value for natural gas, nitrogen, compressed air

<sup>2</sup> shear wave transducer:  
 typical values for natural gas, nitrogen, oxygen, pipe diameters for other fluids on request  
 inner pipe diameter max. recommended/max. extended: in reflection arrangement and for a flow velocity of 15 m/s

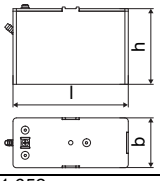
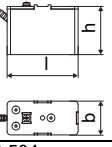
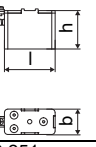

**Lamb wave transducers (zone 2, NL)**

order code		GLG-N*2NL/**	GLH-N*2NL/**	GLK-N*2NL/**	GLM-N*2NL/**	GLP-N*2NL/**	GLQ-N*2NL/**
technical type		G(RT)G1NH3	G(RT)H1NH3	G(RT)K1NH3	G(RT)M1NH3	G(RT)P1NH3	G(RT)Q1NH3
transducer frequency	MHz	0.2	0.3	0.5	1	2	4
<b>fluid pressure<sup>1</sup></b>							
min. extended	bar	metal pipe: 10		metal pipe: 10 (d > 120 mm) 3 (d < 120 mm)	metal pipe: 3 (d < 60 mm)	metal pipe: 3 (d < 35 mm)	metal pipe: 3 (d < 15 mm)
min.	bar	metal pipe: 15 plastic pipe: 1		metal pipe: 15 (d > 120 mm) 10 (d < 120 mm) plastic pipe: 1	metal pipe: 10 (d > 60 mm) 5 (d < 60 mm) plastic pipe: 1	metal pipe: 10 (d > 35 mm) 5 (d < 35 mm) plastic pipe: 1	metal pipe: 10 (d > 15 mm) 5 (d < 15 mm) plastic pipe: 1
<b>inner pipe diameter d<sup>2</sup></b>							
min. extended	mm	180	110	60	30	15	7
min. recommended	mm	220	140	80	40	20	10
max. recommended	mm	900	600	300	150	50	22
max. extended	mm	1400	1000	360	180	60	30
<b>pipe wall thickness</b>							
min.	mm	11	8	5	2.5	1.2	0.6
max.	mm	24	16	10	5	3	1.2
<b>material</b>							
housing		PPSU with stainless steel cap and transducer shoe 304 (1.4301)					
contact surface		PPSU					
degree of protection		IP66			IP65		
<b>transducer cable</b>							
type		1699					
length	m	5			4		3
length (***_*****LC)	m	9					
<b>dimensions</b>							
length l	mm	136.5			84		70
width b	mm	59			40		30
height h	mm	90.5			59		47.5
dimensional drawing							
weight (without cable)	kg	1.652			0.504		0.251
<b>pipe surface temperature</b>							
min.	°C	-40					
max.	°C	+130					
<b>ambient temperature</b>							
min.	°C	-40					
max.	°C	+130					
temperature compensation		x					
<b>explosion protection</b>							
<b>• ATEX/IECEx</b>							
order code		GLG-NA2NL/**	GLH-NA2NL/**	GLK-NA2NL/**	GLM-NA2NL/**	GLP-NA2NL/**	GLQ-NA2NL/**
pipe surface temperature (Ex)							
• min.	°C	-55					
• max.	°C	gas: +150, dust: +140					
marking		CE 0637 II3G II2D Ex nA IIC T6...T2 Gc Ex tb IIIC TX Db					
certification ATEX		IBExU10ATEX1163 X					
certification IECEx		IECEx IBE 12.0005X					

<sup>1</sup> depending on application, typical absolute value for natural gas, nitrogen, compressed air

<sup>2</sup> Lamb wave transducer:  
 typical values for natural gas, nitrogen, oxygen, pipe diameters for other fluids on request  
 inner pipe diameter max. recommended: in reflection arrangement (diagonal arrangement) and for a flow velocity of 15 m/s (30 m/s)  
 inner pipe diameter max. extended: in reflection arrangement (diagonal arrangement) and for a flow velocity of 12 m/s (25 m/s)

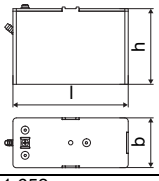
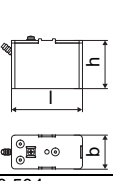
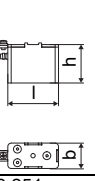
**Lamb wave transducers (zone 1, NL)**

order code		GLG-N*1NL/**	GLH-N*1NL/**	GLK-N*1NL/**	GLM-N*1NL/**	GLP-N*1NL/**	GLQ-N*1NL/**
technical type		G(RT)G1NW3	G(RT)H1NW3	G(RT)K1NW3	G(RT)M1NW3	G(RT)P1NW3	G(RT)Q1NW3
transducer frequency	MHz	0.2	0.3	0.5	1	2	4
<b>fluid pressure<sup>1</sup></b>							
min. extended	bar	metal pipe: 10		metal pipe: 10 (d > 120 mm) 3 (d < 120 mm)	metal pipe: 3 (d < 60 mm)	metal pipe: 3 (d < 35 mm)	metal pipe: 3 (d < 15 mm)
min.	bar	metal pipe: 15 plastic pipe: 1		metal pipe: 15 (d > 120 mm) 10 (d < 120 mm) plastic pipe: 1	metal pipe: 10 (d > 60 mm) 5 (d < 60 mm) plastic pipe: 1	metal pipe: 10 (d > 35 mm) 5 (d < 35 mm) plastic pipe: 1	metal pipe: 10 (d > 15 mm) 5 (d < 15 mm) plastic pipe: 1
<b>inner pipe diameter d<sup>2</sup></b>							
min. extended	mm	180	110	60	30	15	7
min. recommended	mm	220	140	80	40	20	10
max. recommended	mm	900	600	300	150	50	22
max. extended	mm	1400	1000	360	180	60	30
<b>pipe wall thickness</b>							
min.	mm	11	8	5	2.5	1.2	0.6
max.	mm	24	16	10	5	3	1.2
<b>material</b>							
housing		PPSU with stainless steel cap and transducer shoe 304 (1.4301)					
contact surface		PPSU					
degree of protection		IP66			IP65		
<b>transducer cable</b>							
type		1699					
length	m	5			4		3
length (***/****/LC)	m	9					
<b>dimensions</b>							
length l	mm	136.5			84		70
width b	mm	59			40		30
height h	mm	90.5			59		47.5
dimensional drawing							
weight (without cable)	kg	1.652			0.504		0.251
<b>pipe surface temperature</b>							
min.	°C	-40					
max.	°C	+130					
<b>ambient temperature</b>							
min.	°C	-40					
max.	°C	+130					
temperature compensation		x					
<b>explosion protection</b>							
<b>• ATEX/IECEX</b>							
order code		GLG-NA1NL/**	GLH-NA1NL/**	GLK-NA1NL/**	GLM-NA1NL/**	GLP-NA1NL/**	GLQ-NA1NL/**
pipe surface temperature (Ex)							
• min.	°C	-55					
• max.	°C	+140					
marking		CE 0637  II2G II2D Ex q IIC T6...T3 Gb Ex tb IIIC TX Db					
certification ATEX		IBExU07ATEX1168 X					
certification IECEX		IECEX IBE 08.0007X					

<sup>1</sup> depending on application, typical absolute value for natural gas, nitrogen, compressed air

<sup>2</sup> Lamb wave transducer:  
 typical values for natural gas, nitrogen, oxygen, pipe diameters for other fluids on request  
 inner pipe diameter max. recommended: in reflection arrangement (diagonal arrangement) and for a flow velocity of 15 m/s (30 m/s)  
 inner pipe diameter max. extended: in reflection arrangement (diagonal arrangement) and for a flow velocity of 12 m/s (25 m/s)

# Transducer mounting fixture

## Order code

1, 2	3	4	5	6	7...9	no. of character		
transducer mounting fixture	transducer	-	measurement arrangement	size	-	fixation	outer pipe diameter	description
VP								portable Variofix
	A							all transducers
		D						reflection arrangement or diagonal arrangement
		R						reflection arrangement
			M					medium
					C			chains
					N			without fixation
							055	10...550 mm

**portable Variofix VP and chains**

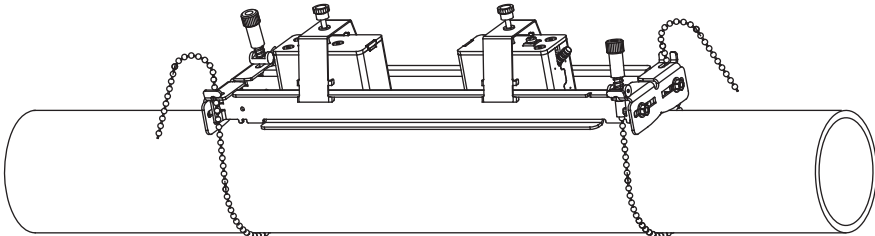

material: stainless steel 304 (1.4301), 301 (1.4310), 303 (1.4305)  
 dimensions: 414 x 94 x 76 mm  
 chain length: 2 m

## Coupling materials for transducers

normal temperature range (4th character of transducer order code = N)		extended temperature range (4th character of transducer order code = E)	
< 100 °C	< 170 °C	< 150 °C	< 200 °C
coupling compound type N	coupling compound type E	coupling compound type E	coupling compound type E or H

### Technical data

type	ambient temperature °C
coupling compound type N	-30...+130
coupling compound type E	-30...+200
coupling compound type H	-30...+250



### Damping material (optional)

Damping material will be used for the gas measurement to reduce acoustic noise influences on the measurement.

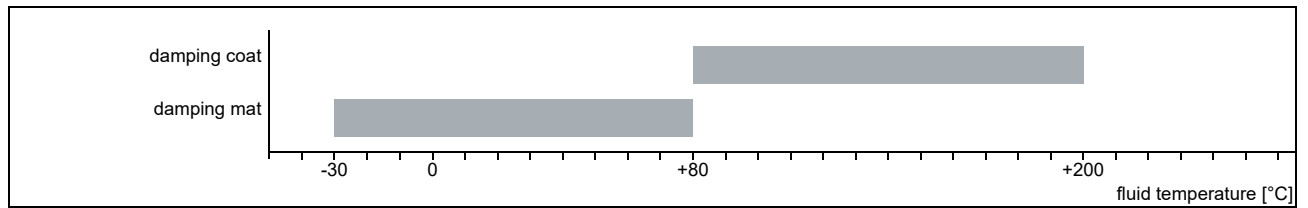

### Damping mats

Damping mats will be used for the gas measurement to reduce acoustic noise influences on the measurement.

Transducer damping mats will be installed below the transducers.

Pipe damping mats will be installed at reflection points, e.g. flange, weld.

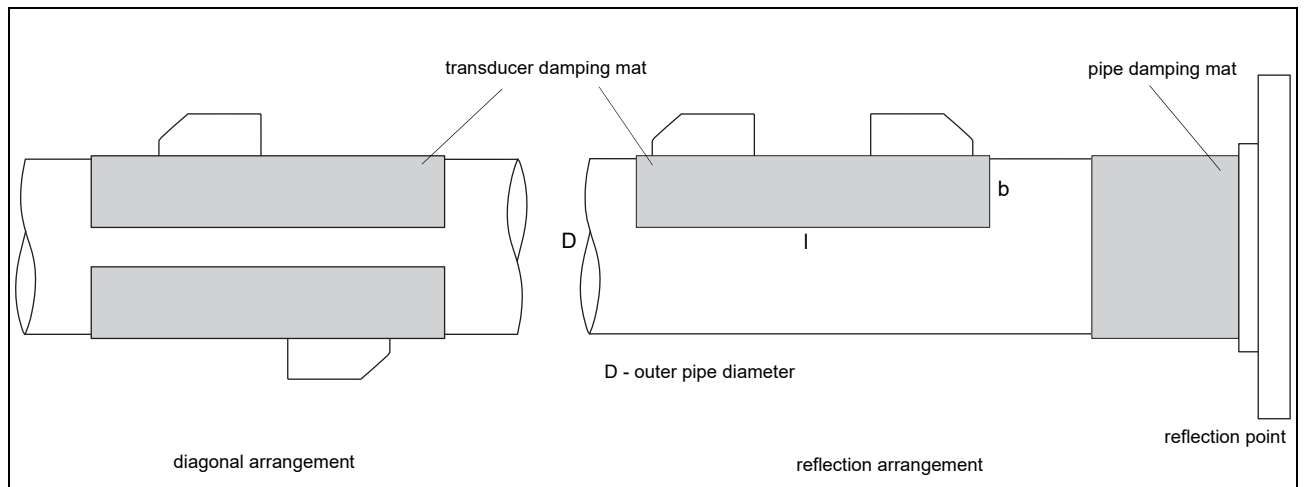

### Selection of damping mats

type	description	outer pipe diameter mm	dimensions l x b x h mm	transducer frequency							technical type	ambient temperature °C	remark
				F	G	H	K	M	P	Q			
<b>transducer damping mat</b>													
D	for temporary installation (multiple use), fixed with coupling compound	< 80	450 x 115 x 0.5	-	-	-	-	x	x	x	D20S3	-25...+60	
		≥ 80	900 x 230 x 0.5	-	-	-	x	x	-	-	D20S2		
			900 x 230 x 1.3	x	x	x	-	-	-	-	D50S2		
<b>pipe damping mat</b>													
A	for temporary installation (multiple use), fixed with coupling compound	< 300	300 x 115 x 0.5	x	x	x	x	x	x	x	A20S4	-25...+60	for quantity see table below
B	self-adhesive	≥ 300	l x 100 x 0.9	x	x	x	x	x	x	-	B35R2	-35...+50	l - see table below

### Quantity for pipe damping mat - type A

(depending on the outer pipe diameter)

outer pipe diameter D mm	transducer frequency	
	F, G, H	K, M, P, Q
100	12	6
200	24	12
300	32	16

### Length of pipe damping mat - type B

(length l depending on transducer frequency and outer pipe diameter)

outer pipe diameter D mm	transducer frequency	
	F, G, H m	K, M, P m
300	12	6
500	32	16
1000	126	63

## Damping coat

For high temperatures it is recommended to apply the damping coat onto the pipe.

### Technical data

material		multipolymeric matrix/inorganic ceramic coating
packing drum	I	1
properties		heat resistant, inert

### Dimensioning

transducer	number of packing drums		
	outer pipe diameter		
	≤400	≤600	≤800
	mm		
F	3	4	5
G	2	3	4
H	1	2	3
K	1	-	-
M	1	-	-
P	1	-	-
Q	1	-	-

## Connection systems

connection system NL	
direct connection/connection with extension cable	transducers technical type
	****W* ****H*

## Cable

transducer cable		
type		<b>1699</b> <b>6111</b>
weight	kg/m	0.094                      0.092
ambient temperature	°C	-55...+200                      -100...+225
cable jacket		
material		PTFE                      PFA
outer diameter	mm	2.9                      2.7
thickness	mm	0.3                      0.5
colour		brown                      white
shield		x                      x
sheath		
material		stainless steel 304 (1.4301)                      stainless steel 304 (1.4301)
outer diameter	mm	8                      8

extension cable		
type		<b>1750</b>
standard length	m	5 10
ambient temperature	°C	< 80
cable jacket		
material		PE
outer diameter	mm	6
thickness	mm	0.5
colour		black
shield		x
sheath		
material		stainless steel 304 (1.4301)
outer diameter	mm	9

## Cable length

transducer frequency	F, G, H, K			M, P			Q			S			
connection system NL													
transducers technical type	x	y	l	x	y	l	x	y	l	x	y	l	
*(DR)***W*	m	2	3	≤ 10	2	2	≤ 10	2	1	≤ 10	-	-	-
*(DR)***H*													
option LC: *(LT)***W*	m	2	7	≤ 10	7	2	≤ 10	8	1	≤ 10	-	-	-
*(LT)***H*													

x, y - transducer cable length

l - max. length of extension cable

# Clamp-on temperature probe (optional)

## Technical data

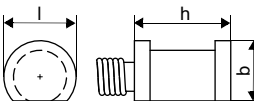
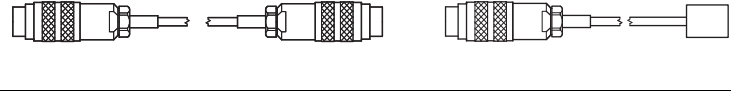
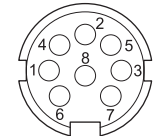
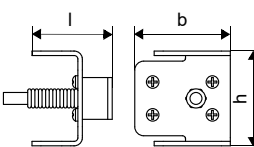
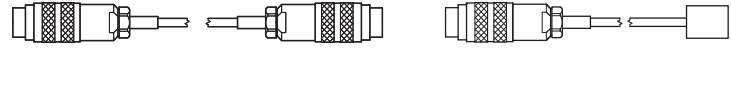
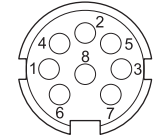
PT12N			
type	Pt100		
connection	4-wire		
measuring range	°C -30...+250		
accuracy T	±(0.15 °C + 2 · 10 <sup>-3</sup> ·  T [°C] ) class A		
accuracy ΔT (2x Pt matched according to EN 1434-1)	≤ 0.1 K (3 K < ΔT < 6 K), more corresponding to EN 1434-1		
response time	s	50	
housing	aluminum		
degree of protection	IP66		
<b>dimensions</b>			
length l	mm	15	
width b	mm	13	
height h	mm	20	
dimensional drawing			
weight	kg	0.25 (without connector)	
<b>accessories</b>			
thermal conductivity paste 200 °C	x		
thermal conductivity foil 250 °C	x		
<b>connection system</b>			
<b>direct connection/connection with extension cable</b>			
			
<b>connection</b>			
	<b>temperature probe</b>	<b>extension cable</b>	<b>connector</b>
			<b>pin</b>
	red	grey	2
	red/blue	red	6
	white/blue	blue	1
	white	white	7
			
<b>cable</b>			
	<b>temperature probe</b>	<b>extension cable</b>	
type	4 x 0.25 mm <sup>2</sup> black	LIYCY 8 x 0.14 mm <sup>2</sup> grey	
standard length	m 3	5/10/25	
max. length	m -	100	
cable jacket	PTFE	PVC	
PT12F			
type	Pt100		
connection	4-wire		
measuring range	°C -50...+250		
accuracy T	±(0.15 °C + 2 · 10 <sup>-3</sup> ·  T [°C] ) class A		
accuracy ΔT (2x Pt matched according to EN 1434-1)	≤ 0.1 K (3 K < ΔT < 6 K), more corresponding to EN 1434-1		
response time	s	8	
housing	PEEK, stainless steel 304 (1.4301), copper		
degree of protection	IP66		
<b>dimensions</b>			
length l	mm	14	
width b	mm	30	
height h	mm	27	
dimensional drawing			
weight	kg	0.32 (without connector)	
<b>accessories</b>			
thermal conductivity paste 200 °C	x		
thermal conductivity foil 250 °C	x		
plastic protection plate, insulation foam	x		
<b>connection system</b>			
<b>direct connection/connection with extension cable</b>			
			
<b>connection</b>			
	<b>temperature probe</b>	<b>extension cable</b>	<b>connector</b>
			<b>pin</b>
	red	grey	2
	red/blue	red	6
	white/blue	blue	1
	white	white	7
			
<b>cable</b>			
	<b>temperature probe</b>	<b>extension cable</b>	
type	4 x 0.25 mm <sup>2</sup> black	LIYCY 8 x 0.14 mm <sup>2</sup> grey	
standard length	m 3	5/10/25	
max. length	m -	100	
cable jacket	PTFE	PVC	

## Fixation

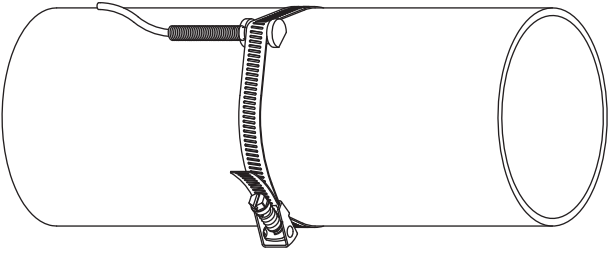
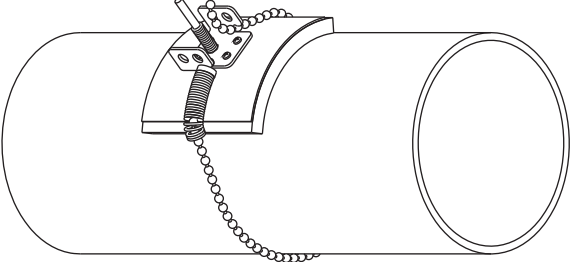
<p><b>tension strap PT12N</b></p> 	<p>material: stainless steel 301 (1.4310), 410 (1.4006)</p>
<p><b>ball chain PT12F</b></p> 	<p>material: stainless steel 316L (1.4404) length: 1 m</p>

## Wall thickness measurement (optional)

The pipe wall thickness is an important pipe parameter which has to be determined exactly for a good measurement. However, the pipe wall thickness often is unknown.

The wall thickness probe can be connected to the transmitter instead of the flow transducers and the wall thickness measurement mode is activated automatically.

Acoustic coupling compound is applied to the wall thickness probe which then is placed firmly on the pipe. The wall thickness is displayed and can be stored directly in the transmitter.

### Technical data

DWR1NZ7		
measuring range <sup>1</sup>	mm	1...250
resolution	mm	0.01
accuracy		1 % ±0.1 mm
fluid temperature	°C	-20...+200, short-time peak max. 500
explosion protection		-
<b>cable</b>		
type		2616
length	m	1.5

<sup>1</sup> The measuring range depends on the attenuation of the ultrasonic signal in the pipe. For strongly attenuating plastics (e.g. PFA, PTFE, PP) the measuring range is smaller.

### Cable

2616		
ambient temperature	°C	<200
<b>cable jacket</b>		
material		FEP
outer diameter	mm	5.1
colour		black
shield		x

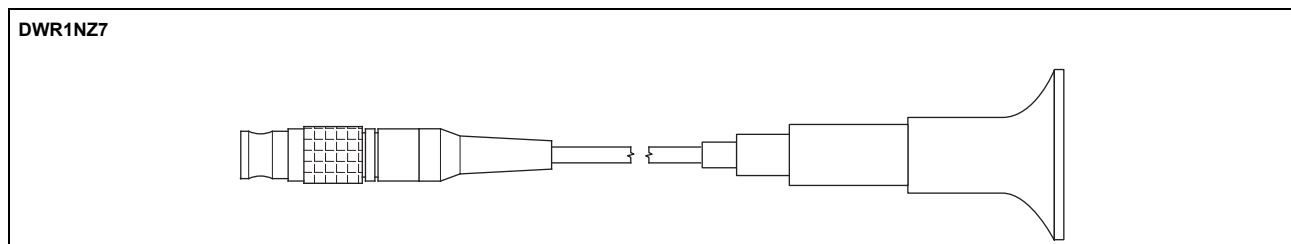

FLEXIM GmbH  
Boxberger Str. 4  
12681 Berlin  
Germany  
Tel.: +49 (30) 93 66 76 60  
Fax: +49 (30) 93 66 76 80  
internet: [www.flexim.com](http://www.flexim.com)  
e-mail: [info@flexim.com](mailto:info@flexim.com)

Subject to change without notification.  
Errors excepted.  
FLUXUS is a registered trademark of FLEXIM GmbH.  
Copyright (©) FLEXIM GmbH 2020