

Gas ultrasonic flowmeter for permanent installation

Transmitter for permanent outdoor wall or pipe mounting

Features

- Precise bidirectional and highly dynamic flow measurement with the non-invasive clamp-on technology
- Up to 4 measuring channels to compensate highly disturbed flow profiles and to facilitate more accurate and repeatable measurements
- Best suitable for applications with limited straight runs
- High precision at fast and slow flow rates, high temperature and zero point stability
- Automatic loading of calibration data and transducer detection for a fast and easy set-up (less than 5 min), providing precise and long-term stable results
- User-friendly design
- Transducers available for a wide range of inner pipe diameters and fluid temperatures
- Transmitter and transducers for usage in hazardous areas are available
- Measurement is unaffected by gas density, viscosity, composition, dust, humidity, temperature or pressure

Applications

- Process and control measurements in gas production, transportation and processing
- Check metering for custody transfer meter and health monitoring
- Lost and unaccounted for gas – segmentation metering and balancing
- Standard volume correction depending on temperature and pressure
- For application in explosive atmospheres (ATEX, IECEx, FM Class I Div. 2)



FLUXUS G706



4 transducer pairs at one measuring point

Function	3
Measurement principle	3
Calculation of volumetric flow rate	3
Number of sound paths	4
Calculation of standard volumetric flow rate	5
Transmitter	6
Technical data	6
Dimensions	9
2" pipe mounting kit	9
Terminal assignment	10
Transducers	11
Transducer selection	11
Transducer order code	14
Technical data	15
Transducer mounting fixture	26
Coupling materials for transducers	28
Damping material (optional)	29
Damping mats	29
Damping coat	30
Connection systems	31
Junction box	33
Technical data	33
Dimensions	34
2" pipe mounting kit	34
Clamp-on temperature probe (optional)	35
Technical data	35
Fixation	37
Junction box	38

Function

Measurement principle

The transducers are mounted on the pipe which is completely filled with the fluid. The ultrasonic signals are emitted alternately by a transducer and received by the other. The physical quantities are determined from the transit times of the ultrasonic signals.

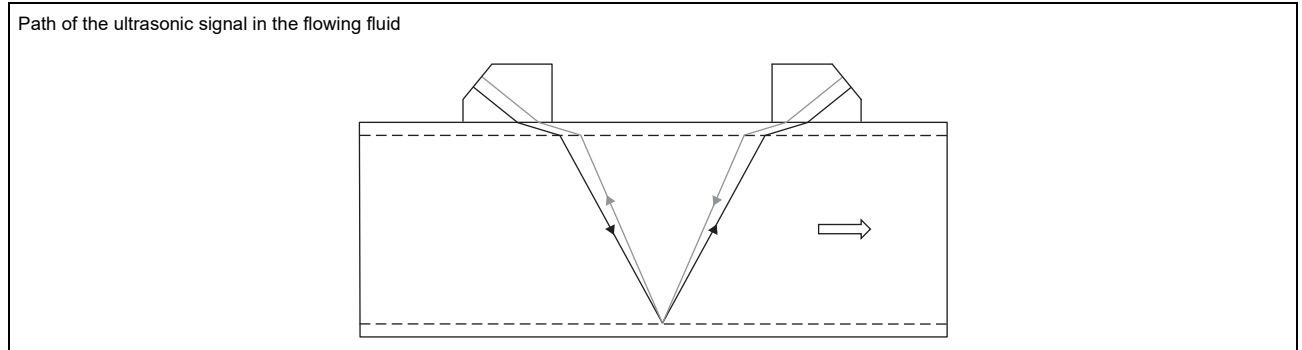

As the fluid where the ultrasound propagates is flowing, the transit time of the ultrasonic signal in flow direction is shorter than the one against the flow direction.

The transit time difference Δt is measured and allows the flowmeter to determine the average flow velocity along the propagation path of the ultrasonic signals. A flow profile correction is then performed in order to obtain the area averaged flow velocity, which is proportional to the volumetric flow rate.

The integrated microprocessors control the entire measuring cycle. The received ultrasonic signals are checked for measurement usability and evaluated for their reliability. Noise signals are eliminated.

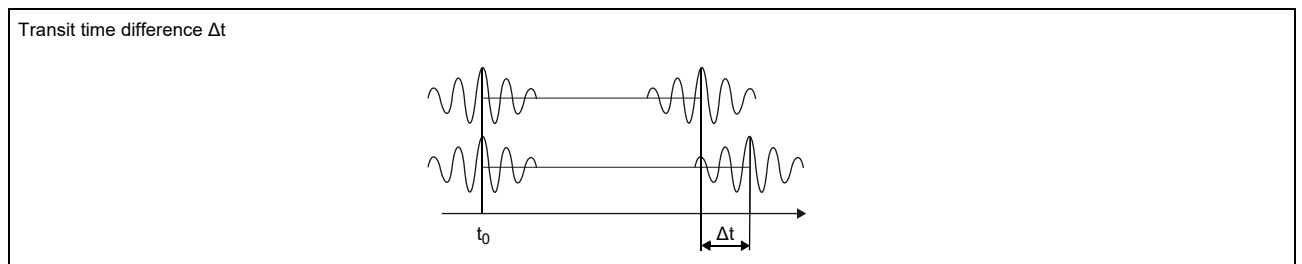

Calculation of volumetric flow rate

$$\dot{V} = k_{Re} \cdot A \cdot k_a \cdot \frac{\Delta t}{2 \cdot t_{\gamma}}$$

where

- \dot{V} - volumetric flow rate
- k_{Re} - fluid mechanics calibration factor
- A - cross-sectional pipe area
- k_a - acoustical calibration factor
- Δt - transit time difference
- t_{γ} - average of transit times in the fluid

Number of sound paths

The number of sound paths is the number of transits of the ultrasonic signal through the fluid in the pipe. Depending on the number of sound paths, the following methods of installation exist:

- **reflection arrangement**

The number of sound paths is even. The transducers are mounted on the same side of the pipe. Correct positioning of the transducers is easy.

- **diagonal arrangement**

The number of sound paths is odd. The transducers are mounted on opposite sides of the pipe. In the case of a high signal attenuation by the fluid, pipe and coatings, diagonal arrangement with 1 sound path will be used.

The preferred method of installation depends on the application. While increasing the number of sound paths increases the accuracy of the measurement, signal attenuation increases as well. The optimum number of sound paths for the parameters of the application will be determined automatically by the transmitter.

As the transducers can be mounted with the transducer mounting fixture in reflection arrangement or diagonal arrangement, the number of sound paths can be adjusted optimally for the application.

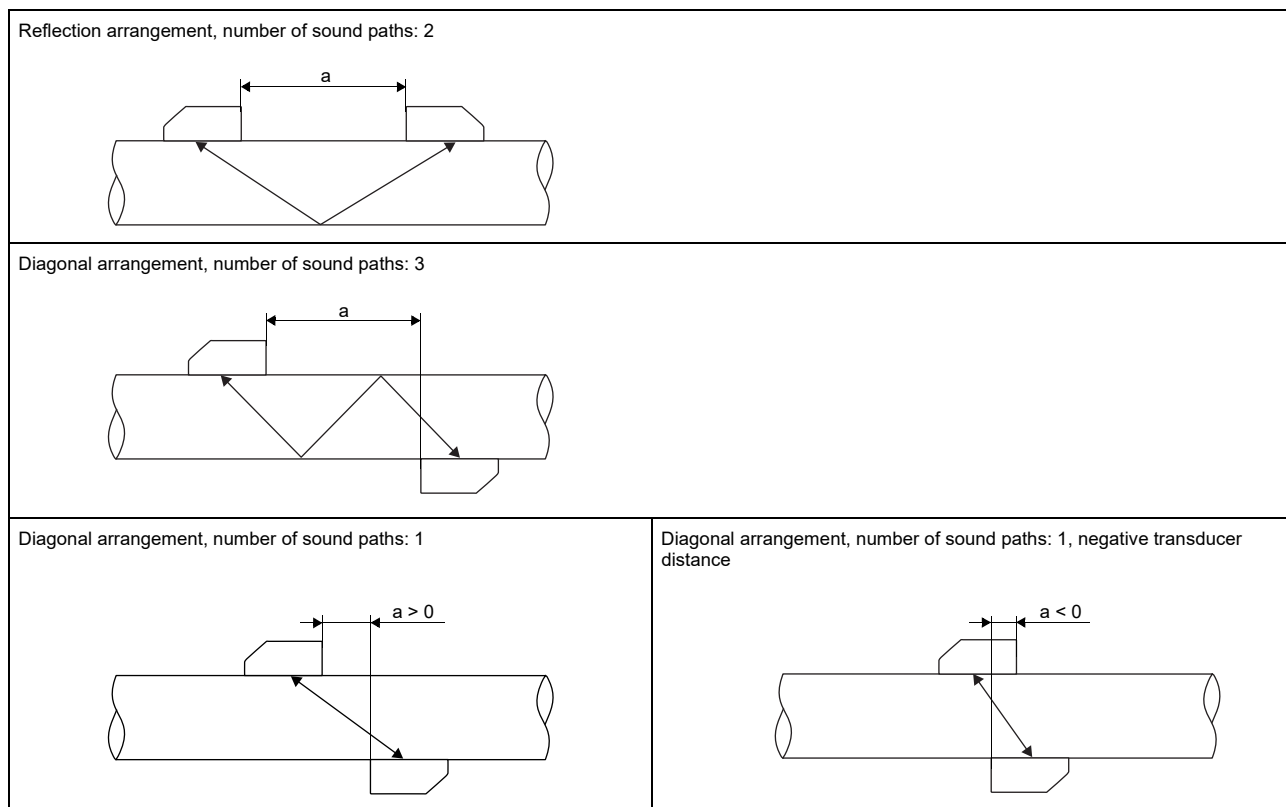

a - transducer distance

Calculation of standard volumetric flow rate

The standard volumetric flow rate can be selected as physical quantity. It is calculated with the following formula:

$$\dot{V}_N = \dot{V} \cdot \frac{p}{p_N} \cdot \frac{T_N}{T} \cdot \frac{1}{K}$$

where

- \dot{V}_N - standard volumetric flow rate
- \dot{V} - operating volumetric flow rate
- p_N - standard pressure (absolute value)
- p - operating pressure (absolute value)
- T_N - standard temperature in K
- T - operating temperature in K
- K - compressibility coefficient of gas: ratio of the compressibility factors of the gas at operating conditions and at standard conditions Z/Z_N

The operational pressure p and the operational temperature T of the fluid will be entered directly as fixed values into the transmitter.

or:



If inputs are installed (optional), pressure and temperature can be measured by the customer and fed in the transmitter.

The gas compressibility coefficient K of the gas is entered in the transmitter:

- as fixed value or
- as approximation, e.g. according to AGA8 or GERG

Transmitter

Technical data

	FLUXUS G706**-NN FLUXUS G706**-A2	FLUXUS G706**-F2
		
design	field device with 4 measuring channels in stainless steel housing	
measurement		
measurement principle	transit time difference correlation principle	
flow velocity	m/s	0.01...35, depending on pipe diameter
repeatability		0.15 % MV ±0.005 m/s
fluid	all acoustically conductive gases, e.g. nitrogen, air, oxygen, hydrogen, argon, helium, ethylene, propane	
temperature compensation	corresponding to the recommendations in ANSI/ASME MFC-5.1-2011	
measurement uncertainty (volumetric flow rate)		
measurement uncertainty of the measuring system ¹		±0.3 % MV ±0.005 m/s
measurement uncertainty at the measuring point		±1...2 % MV ±0.005 m/s, depending on the application
transmitter		
power supply		<ul style="list-style-type: none"> • 100...230 V/50...60 Hz or • 20...32 V DC or • 11...16 V DC
power consumption	W	< 20
number of measuring channels		4
damping	s	0...100 (adjustable)
measuring cycle	Hz	100...1000 (1 channel)
response time	s	1 (1 channel)
housing material		stainless steel 316L (1.4404)
degree of protection		IP66
dimensions	mm	see dimensional drawing
weight	kg	7.2
fixation		wall mounting, optional: 2" pipe mounting
ambient temperature	°C	-40...+60 (< -20 °C without operation of the display) -20...+55
display		2 x 16 characters, dot matrix, backlight
menu language		English, German, French, Dutch, Spanish
explosion protection		
• ATEX/IECEX		
transmitter		G706**-A2
marking		CE 0637 Ex II 3G II 2D Ex nA nC ic IIC T4 Gc Ex tb IIIC T120 °C Db T _a -40...+60 °C
certification ATEX		IBExU11ATEX1015
certification IECEX		IECEX IBE 11.0008
• FM		
marking		 NI/Cl. I,II,III/Div. 2/ GP. A,B,C,D,E,F,G/ T5 -20°C≤T _a ≤55°C IP64
measuring functions		
physical quantities		operating volumetric flow rate, standard volumetric flow rate, mass flow rate, flow velocity
totaliser		volume, mass
calculation functions		average, difference, sum
diagnostic functions		sound speed, signal amplitude, SNR, SCNR, standard deviation of amplitudes and transit times

¹ with aperture calibration of the transducers

² outside the explosive atmosphere (housing cover open)

		FLUXUS G706**-NN FLUXUS G706**-A2	FLUXUS G706**-F2
communication interfaces			
service interfaces		<ul style="list-style-type: none"> • RS232¹ • USB (with adapter)¹ 	
process interfaces		max. 1 option: <ul style="list-style-type: none"> • RS485 (ASCII sender) • Modbus RTU • HART • FF H1 • SD card (nonEx) 	max. 1 option: <ul style="list-style-type: none"> • RS485 (ASCII sender) • Modbus RTU • HART • FF H1
accessories			
data transmission kit		<ul style="list-style-type: none"> • cable • adapter RS232 RS232 - USB	
software		<ul style="list-style-type: none"> • FluxDiagReader: reading of measured values and parameters, graphical presentation • FluxDiag (optional): reading of measurement data, graphical presentation, report generation 	
data logger			
loggable values		all physical quantities, totalised physical quantities and diagnostic values	
capacity		> 100 000 measured values	
SD card, removable (nonEx, optional)			
loggable values		all physical quantities and totalised physical quantities	-
capacity		min. 2 GB	-
outputs			
		The outputs are galvanically isolated from the transmitter.	
number		on request active inputs and outputs: max. 4	
• switchable current output			
		All switchable current outputs are jointly switched to active or passive.	
range	mA	4...20 (3.2...22)	
accuracy		0.04 % MV ±3 µA	
active output		$R_{ext} < 350 \Omega$	
passive output		$U_{ext} = 8...30 \text{ V}$, depending on R_{ext} ($R_{ext} < 1 \text{ k}\Omega$ at 30 V)	
• HART			
range	mA	4...20	
accuracy		0.1 % MV ±15 µA	
active output		$U_{int} = 24 \text{ V}$, $R_{ext} < 500 \Omega$	
passive output		$U_{ext} = 10...24 \text{ V DC}$, depending on R_{ext} ($R_{ext} < 1 \text{ k}\Omega$ at 24 V)	
• voltage output			
range	V	0...1 or 0...10	
accuracy		0...1 V: 0.1 % MV ±1 mV 0...10 V: 0.1 % MV ±10 mV	
internal resistance		$R_{int} = 500 \Omega$	
• frequency output			
range	kHz	0...5	
optorelay		24 V/4 mA, $R_{int} = 66.5 \Omega$	
• binary output			
optorelay		26 V/100 mA	
open collector		24 V/4 mA, P1...P6: $R_{int} = 22 \Omega$	
Reed relay		48 V/100 mA, P1...P6: $R_{int} = 22 \Omega$	
binary output as alarm output			
• functions		limit, change of flow direction or error	
binary output as pulse output			
• functions		mainly for totalising	
• pulse value	units	0.01...1000	
• pulse width	ms	optorelay: 1...1000 Reed relay, open collector: 80...1000	

¹ with aperture calibration of the transducers

² outside the explosive atmosphere (housing cover open)

	FLUXUS G706**-NN FLUXUS G706**-A2	FLUXUS G706**-F2
inputs		
	The inputs are galvanically isolated from the transmitter.	
number	max. 4, on request active inputs and outputs: max. 4	
• temperature input		
type	Pt100/Pt1000	
connection	4-wire	
range	°C	-150...+560
resolution	K	0.01
accuracy	±0.01 % MV ±0.03 K	
• current input		
accuracy	0.1 % MV ±10 μ	
active input	U _{int} = 24 V, R _{int} = 50 Ω, P _{int} < 0.5 W, not short-circuit proof	
• range	mA	0...20
passive input	R _{int} = 50 Ω, P _{int} < 0.3 W	
• range	mA	-20...+20
• voltage input		
range	V	0...1
accuracy	0.1 % MV ±1 mV	
internal resistance	R _{int} = 1 MΩ	
• binary input		
switching signal	5...30 V, 1 mA	5...26 V, 1 mA
functions	<ul style="list-style-type: none"> • reset of the measured values • reset of the totalisers • stop of the totalisers • activation of the measuring mode for highly dynamic flows 	

¹ with aperture calibration of the transducers

² outside the explosive atmosphere (housing cover open)

Dimensions

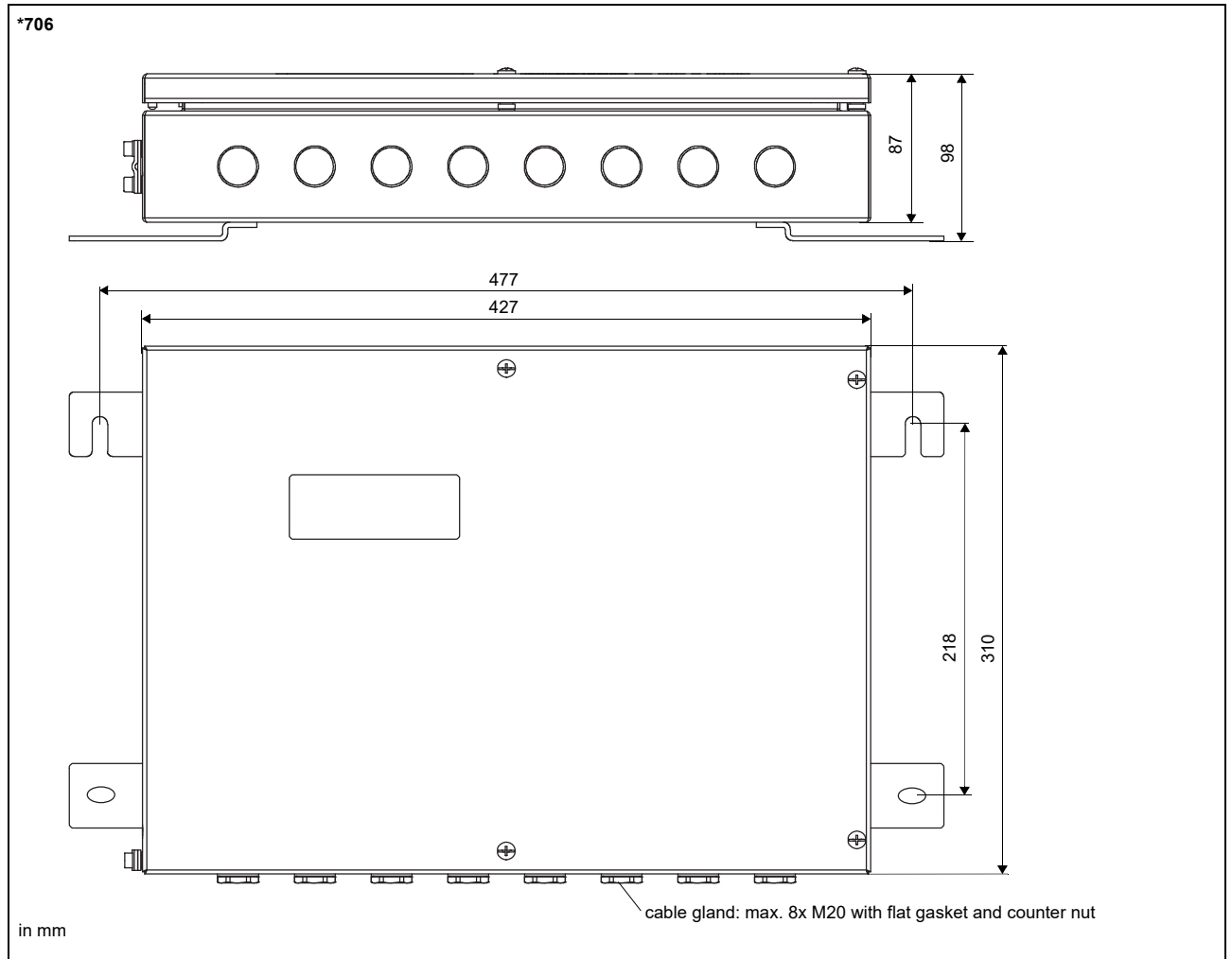

2" pipe mounting kit

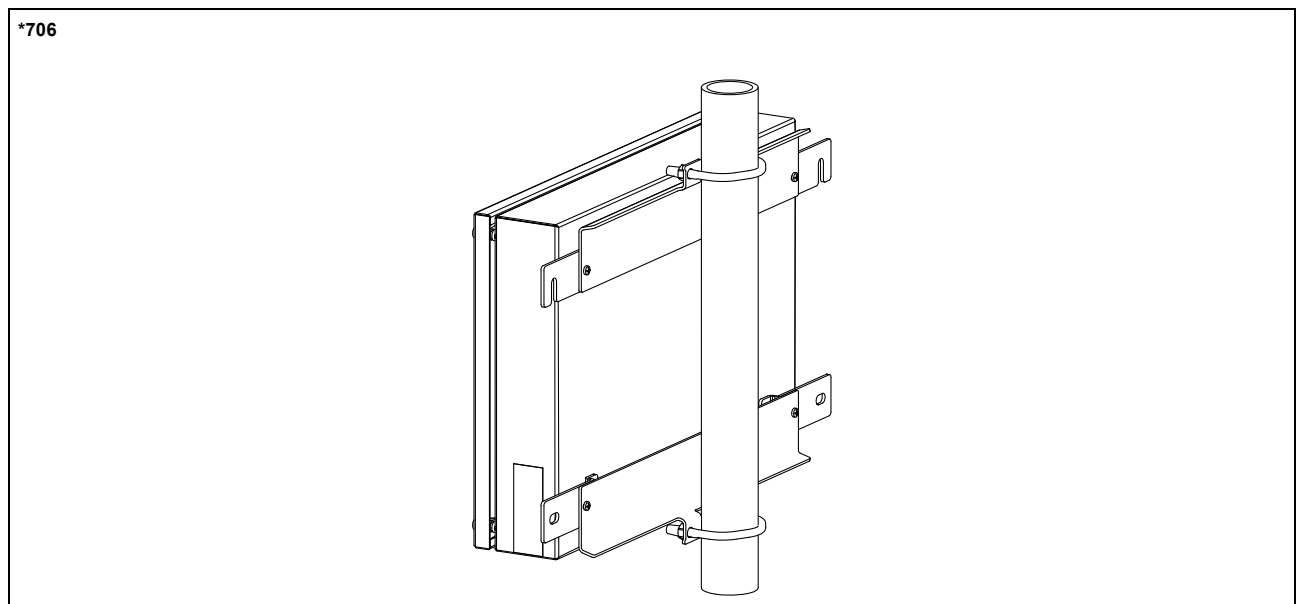

Terminal assignment

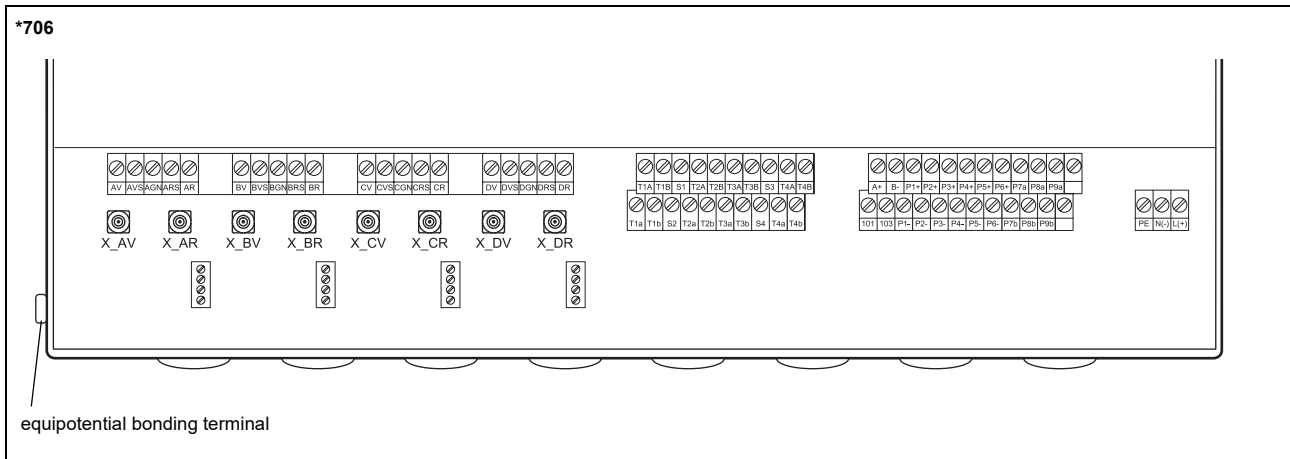

power supply ¹				
terminal	connection (AC)		connection (DC)	
PE	earth		earth	
N(-)	neutral		-	
L(+)	phase		+	
transducers				
transducer cable (transducers *****8*, ****LI*) extension cable (transducers *****8*, ****LI*, *****52)			transducer cable (transducers *****52)	
measuring channel A, B, C, D			measuring channel A, B, C, D	
terminal	connection	transducer	terminal	connection
xV	signal	↑	X_xV	SMB connector
xVS	shield			
xRS	shield	⤴	X_xR	SMB connector
xR	signal			
outputs ^{1, 2}				
terminal	connection	terminal	connection	communication interface
P1+...P6+ P1-...P6-	current output, voltage output, frequency output, binary output (Reed relay, open collector), HART (P1)	A+ B-	signal + signal -	<ul style="list-style-type: none"> • RS485 • Modbus RTU • FF
P7a...P9a P7b...P9b	binary output (Reed relay, optorelay)	101	shield	
analog inputs ^{1, 2}				
terminal	temperature probe		passive sensor	active sensor
	direct connection	connection with extension cable	connection	connection
T1a...T4a	red	red	not connected	not connected
T1A...T4A	red/blue	grey	-	+
T1b...T4b	white/blue	blue	+	not connected
T1B...T4B	white	white	not connected	-
S1, S3	shield	shield	not connected	not connected
binary inputs ^{1, 2}				
terminal				
P1+...P2+, P1-...P2-				

¹ cable (by customer):
 - e.g. flexible wires, with insulated wire ferrules, wire cross-section: 0.5...1.5 mm²
 - with ferrite nut outer diameter of the cable max. 7.6 mm

² The number, type and terminal assignment are customised.

Transducers

Transducer selection

Step 1a

Select a Lamb wave transducer:

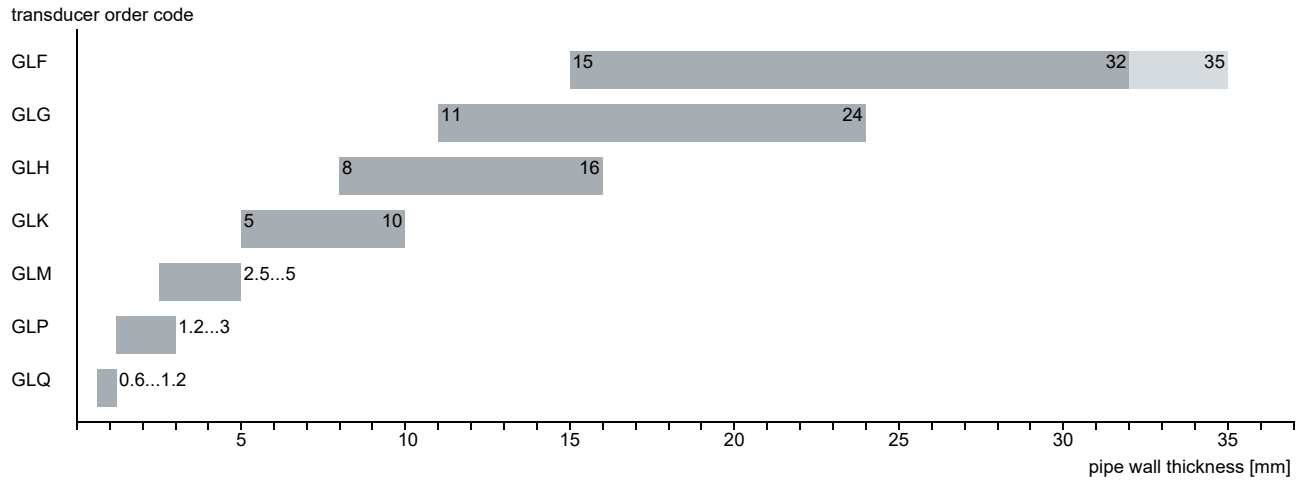

Step 1b

If the pipe wall thickness is not in the range of the Lamb wave transducers, select a shear wave transducer:

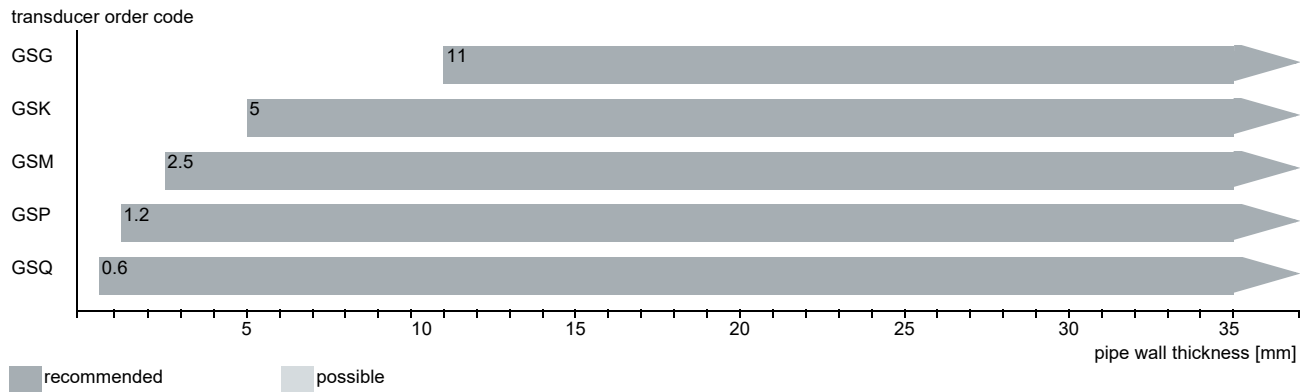

Step 2

inner pipe diameter d dependent on the flow velocity v of the fluid in the pipe

The transducers are selected from the characteristics (see next page). Lamb wave transducers are selected from the left column, shear wave transducers from the right column.

Lamb wave transducers: If the values d and v are not in the range, the diagonal arrangement with 1 sound path may be used, i.e. the same characteristics can be used with doubling the inner pipe diameter. If the values are still not in the range, shear waves transducers regarding the pipe wall thickness have to be selected in step 1b.

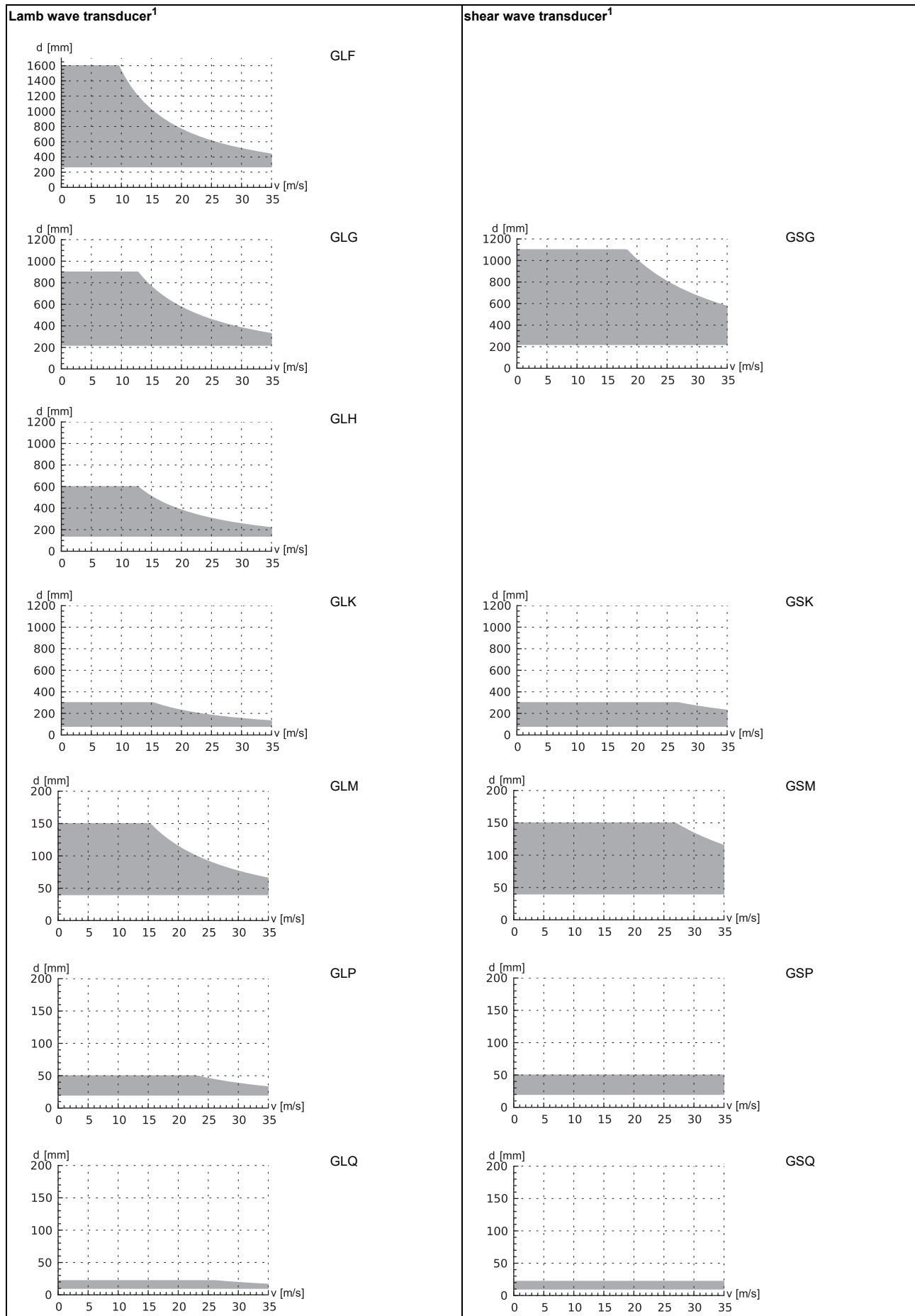

¹ inner pipe diameter and max. flow velocity for a typical application with natural gas, nitrogen, oxygen in reflection arrangement with 2 sound paths (Lamb wave transducers)/1 sound path (shear wave transducers)

Step 3

min. fluid pressure

Lamb wave transducer			
transducer order code	fluid pressure ¹ [bar]		
	metal pipe		plastic pipe
	min.	min. extended	min.
GLF	15	10	1
GLG	15	10	1
GLH	15	10	1
GLK	15 (d > 120 mm) 10 (d < 120 mm)	10 (d > 120 mm) 3 (d < 120 mm)	1
GLM	10 (d > 60 mm) 5 (d < 60 mm)	3 (d < 60 mm)	1
GLP	10 (d > 35 mm) 5 (d < 35 mm)	3 (d < 35 mm)	1
GLQ	10 (d > 15 mm) 5 (d < 15 mm)	3 (d < 15 mm)	1

shear wave transducer			
transducer order code	fluid pressure ¹ [bar]		
	metal pipe		plastic pipe
	min.	min. extended	min.
GSG	30	20	1
GSK	30	20	1
GSM	30	20	1
GSP	30	20	1
GSQ	30	20	1

¹ depending on the application, typical absolute value for natural gas, nitrogen, compressed air

d - inner pipe diameter

Example

step					
1	pipe wall thickness	mm	14.3	8.6	38
	selected transducer		GLG or GLH	GLH or GLK	GS
2	inner pipe diameter	mm	581	96.8	143
	max. flow velocity	m/s	15	30	30
	selected transducer		GLG	GLK	GSK
3	min. fluid pressure	bar	20	15	40
	selected transducer		GLG	GLK	GSK

Step 4

for the characters 4...11 of the transducer order code (ambient temperature, explosion protection, connection system, extension cable) see page 14

Step 5

for the technical data of the selected transducer see page 15 et seqq.

Transducer order code

1, 2	3	4	5, 6	7, 8	9...11	no. of character				
transducer	transducer frequency	-	ambient temperature	explosion protection	connection system	-	extension cable	/	option	description
GS										set of ultrasonic flow transducers for gas measurement, shear wave
GL										set of ultrasonic flow transducers for gas measurement, Lamb wave
	F									0.15 MHz
	G									0.2 MHz
	H									0.3 MHz
	K									0.5 MHz
	M									1 MHz
	P									2 MHz
	Q									4 MHz
		N								normal temperature range
		E								extended temperature range
			NN							not explosion-proof
			A2							ATEX zone 2/IECEX zone 2
			A1							ATEX zone 1/IECEX zone 1
			F2							FM Class I Div. 2
				TS						direct connection or connection via junction box
						XXX				0 m: without extension cable > 0 m: with extension cable
							LC			long transducer cable
							IP68			degree of protection IP68
							OS			housing with stainless steel 316

Technical data



Shear wave transducers (zone 2 - FM Class I Div. 2 - nonEx, TS)

order code		GSG-N**TS/**	GSK-N**TS/**	GSM-N**TS/**	GSP-N**TS/**	GSQ-N**TS/**
technical type		G(DL)G1N52	G(DL)K1N52	G(DL)M2N52	G(DL)P2N52	G(DL)Q2N52
transducer frequency	MHz	0.2	0.5	1	2	4
fluid pressure¹						
min. extended	bar	metal pipe: 20				
min.	bar	metal pipe: 30, plastic pipe: 1				
inner pipe diameter d²						
min. extended	mm	180	60	30	15	7
min. recommended	mm	220	80	40	20	10
max. recommended	mm	900	300	150	50	22
max. extended	mm	1100	360	180	60	30
pipe wall thickness						
min.	mm	11	5	2.5	1.2	0.6
material						
housing		PEEK with stainless steel cover 304 (1.4301), ***.****/OS: 316L (1.4404)				
contact surface		PEEK				
degree of protection		IP67				
transducer cable						
type		1699				
length	m	5	4			3
length (***.*****/LC)	m	9				
dimensions						
length l	mm	129.5	126.5	64	40	
width b	mm	51	51	32	22	
height h	mm	67	67.5	40.5	25.5	
dimensional drawing						
weight (without cable)	kg	0.47	0.36	0.066	0.016	
pipe surface temperature						
min.	°C	-40				
max.	°C	+130				
ambient temperature						
min.	°C	-40				
max.	°C	+130				
temperature compensation		x				
explosion protection						
• ATEX/IECEX						
order code		GSG-NA2TS/**	GSK-NA2TS/**	GSM-NA2TS/**	GSP-NA2TS/**	GSQ-NA2TS/**
pipe surface temperature (Ex)		• min. °C -55 • max. °C gas: +190, dust: +180				
marking		CE 0637 Ex II 3G II 2D Ex nA IIC T6...T3 Gc Ex tb IIIC T80 °C...T185 °C Db				
certification ATEX		IBExU10ATEX1163 X				
certification IECEX		IECEX IBE 12.0005X				
• FM						
order code		GSG-NF2TS/**	GSK-NF2TS/**	GSM-NF2TS/**	GSP-NF2TS/**	GSQ-NF2TS/**
pipe surface temperature (Ex)		• min. °C -40 • max. °C +125 +190				
degree of protection		IP66				
marking		NI/Cl. I,II,III/Div. 2 / GP A,B,C,D,E,F,G/ Temp. Codes dwg 3860				

¹ depending on the application, typical absolute value for natural gas, nitrogen, compressed air

² shear wave transducer:
 typical values for natural gas, nitrogen, oxygen; pipe diameters for other fluids on request
 inner pipe diameter max. recommended/max. extended: in reflection arrangement and for a flow velocity of 15 m/s

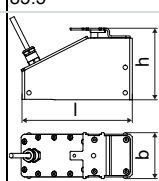
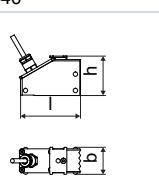
Shear wave transducers (zone 2 - nonEx, TS, IP68)



order code		GSG-N**TS/IP68	GSK-N**TS/IP68	GSM-N**TS/IP68	GSP-N**TS/IP68
technical type		GDG1LI8	GDK1LI8	GDM2LI8	GDP2LI8
transducer frequency	MHz	0.2	0.5	1	2
fluid pressure¹					
min. extended	bar	metal pipe: 20			
min.	bar	metal pipe: 30, plastic pipe: 1			
inner pipe diameter d²					
min. extended	mm	180	60	30	15
min. recommended	mm	220	80	40	20
max. recommended	mm	900	300	150	50
max. extended	mm	1100	360	180	60
pipe wall thickness					
min.	mm	11	5	2.5	1.2
material					
housing		PEEK with stainless steel cover 316Ti (1.4571)			
contact surface		PEEK			
degree of protection		IP68 ³			
transducer cable					
type		2550			
length	m	12			
dimensions					
length l	mm	130		72	
width b	mm	54		32	
height h	mm	83.5		46	
dimensional drawing					
weight (without cable)	kg	0.43		0.085	
pipe surface temperature					
min.	°C	-40			
max.	°C	+100			
ambient temperature					
min.	°C	-40			
max.	°C	+100			
temperature compensation		x			
explosion protection					
• ATEX/IECEx					
order code		GSG-NA2TS/IP68	GSK-NA2TS/IP68	GSM-NA2TS/IP68	GSP-NA2TS/IP68
pipe surface temperature (Ex)					
• min.	°C	-40			
• max.	°C	gas: +90, dust: +80			
marking		CE 0637  II3G II2D Ex nA IIC T6...T5 Gc Ex tb IIIC T80 °C...T85 °C Db			
certification ATEX		IBExU10ATEX1163 X			
certification IECEx		IECEx IBE 12.0005X			

¹ depending on the application, typical absolute value for natural gas, nitrogen, compressed air

² shear wave transducer:
 typical values for natural gas, nitrogen, oxygen; pipe diameters for other fluids on request
 inner pipe diameter max. recommended/max. extended: in reflection arrangement and for a flow velocity of 15 m/s

³ test conditions: 3 months/2 bar (20 m)/20 °C

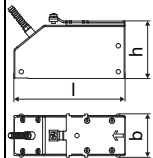
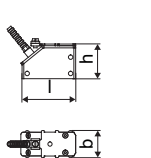
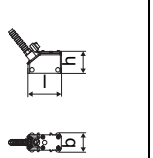
Shear wave transducers (zone 2 - FM Class I Div. 2 - nonEx, TS, extended temperature range)

order code		GSG-ENNTS/**	GSK-ENNTS/**	GSM-E**TS/**	GSP-E**TS/**	GSQ-E**TS/**
technical type		G(DL)G1E52	G(DL)K1E52	G(DL)M2E52	G(DL)P2E52	G(DL)Q2E52
transducer frequency	MHz	0.2	0.5	1	2	4
fluid pressure¹						
min. extended	bar	metal pipe: 20		metal pipe: 20		
min.	bar	metal pipe: 30, plastic pipe: 1		metal pipe: 30, plastic pipe: 1		
inner pipe diameter d²						
min. extended	mm	180	60	30	15	7
min. recommended	mm	220	80	40	20	10
max. recommended	mm	900	300	150	50	22
max. extended	mm	1100	360	180	60	30
pipe wall thickness						
min.	mm	11	5	2.5	1.2	0.6
material						
housing		PPSU with stainless steel cover 304 (1.4301), ***-*****/OS: 316L (1.4404)		PI with stainless steel cover 304 (1.4301), ***-*****/OS: 316L (1.4404)		
contact surface		PPSU		PI		
degree of protection		IP65		IP56		
transducer cable						
type		1699		6111		
length	m	5		4		3
length (***-*****/LC)	m	9		9		
dimensions						
length l	mm	129.5		64		40
width b	mm	51		32		22
height h	mm	67		40.5		25.5
dimensional drawing						
weight (without cable)	kg	0.82		0.066		0.017
pipe surface temperature						
min.	°C	-40		-30		-30
max.	°C	+170		+240 ³		+200
ambient temperature						
min.	°C	-40		-30		-30
max.	°C	+170		+40 +60 ⁴ +200 ⁵		+200
temperature compensation		x		x		
explosion protection						
• ATEX/IECEX						
order code		-		GSM-EA2TS/**	GSP-EA2TS/**	GSQ-EA2TS/**
pipe surface temperature (Ex)		-		-		
• min.	°C	-		-45		
• max.	°C	-		gas: +235 ³ , dust: +225 ³		
marking		-		CE 0637 Ex II 3G II 2D Ex nA IIC T6...T2 Gc Ex tb IIIA T80 °C...230 °C Db		
certification ATEX		-		IBExU10ATEX1163 X		
certification IECEX		-		IECEX IBE 12.0005X		
• FM						
order code		-		GSM-EF2TS/**	GSP-EF2TS/**	GSQ-EF2TS/**
pipe surface temperature (Ex)		-		-		
• min.	°C	-		-40		
• max.	°C	-		+235 ³		
degree of protection		-		IP66		
marking		-		 NI/CI. I,II,III/Div. 2 / GP A,B,C,D,E,F,G/ Temp. Codes dwg 3860		

¹ depending on the application, typical absolute value for natural gas, nitrogen, compressed air

² shear wave transducer:
typical values for natural gas, nitrogen, oxygen; pipe diameters for other fluids on request
inner pipe diameter max. recommended/max. extended: in reflection arrangement and for a flow velocity of 15 m/s

³ > +200 °C:
Variofix C without cover or Variofix L
observe the insulation instruction
Ex: ambient temperature max. +40 °C

⁴ pipe surface temperature +200...+240 °C: Variofix C without cover

⁵ pipe surface temperature max. +200 °C

Shear wave transducers (zone 1, TS)

order code		GSG-N*1TS/**	GSK-N*1TS/**	GSM-N*1TS/**	GSP-N*1TS/**	GSQ-N*1TS/**
technical type		G(DL)G1N81	G(DL)K1N81	G(DL)M2N81	G(DL)P2N81	G(DL)Q2N81
transducer frequency	MHz	0.2	0.5	1	2	4
fluid pressure¹						
min. extended	bar	metal pipe: 20				
min.	bar	metal pipe: 30, plastic pipe: 1				
inner pipe diameter d²						
min. extended	mm	180	60	30	15	7
min. recommended	mm	220	80	40	20	10
max. recommended	mm	900	300	150	50	22
max. extended	mm	1100	360	180	60	30
pipe wall thickness						
min.	mm	11	5	2.5	1.2	0.6
material						
housing		PEEK with stainless steel cover 304 (1.4301), ***-****/OS: 316L (1.4404)				
contact surface		PEEK				
degree of protection		IP65	IP66			IP65
transducer cable						
type		1699				
length	m	5		4		3
length (**-****/LC)	m	9				
dimensions						
length l	mm	129.5	126.5	64		40
width b	mm	51	51	32		22
height h	mm	67	67.5	40.5		25.5
dimensional drawing						
weight (without cable)	kg	0.47	0.36	0.066		0.016
pipe surface temperature						
min.	°C	-40				
max.	°C	+130				
ambient temperature						
min.	°C	-40				
max.	°C	+130				
temperature compensation		x				
explosion protection						
• ATEX/IECEX						
order code		GSG-NA1TS/**	GSK-NA1TS/**	GSM-NA1TS/**	GSP-NA1TS/**	GSQ-NA1TS/**
pipe surface temperature (Ex)						
• min.	°C	-55				
• max.	°C	+180				
marking		CE 0637 Ex II2G II2D Ex q IIC T6...T3 Gb Ex tb IIIC T80 °C...T185 °C Db				
certification ATEX		IBExU07ATEX1168 X				
certification IECEX		IECEX IBE 08.0007X				

¹ depending on the application, typical absolute value for natural gas, nitrogen, compressed air

² shear wave transducer:
 typical values for natural gas, nitrogen, oxygen; pipe diameters for other fluids on request
 inner pipe diameter max. recommended/max. extended: in reflection arrangement and for a flow velocity of 15 m/s

Shear wave transducers (zone 1, TS, IP68)

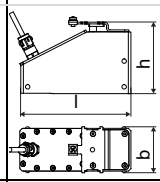
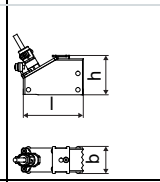

order code		GSG-N*1TS/IP68	GSK-N*1TS/IP68	GSM-N*1TS/IP68	GSP-N*1TS/IP68
technical type		GDG1LI1	GDK1LI1	GDM2LI1	GDP2LI1
transducer frequency	MHz	0.2	0.5	1	2
fluid pressure¹					
min. extended	bar	metal pipe: 20			
min.	bar	metal pipe: 30, plastic pipe: 1			
inner pipe diameter d²					
min. extended	mm	180	60	30	15
min. recommended	mm	220	80	40	20
max. recommended	mm	900	300	150	50
max. extended	mm	1100	360	180	60
pipe wall thickness					
min.	mm	11	5	2.5	1.2
material					
housing		PEEK with stainless steel cover 316Ti (1.4571)			
contact surface		PEEK			
degree of protection		IP68 ³			
transducer cable					
type		2550			
length	m	12			
dimensions					
length l	mm	130		72	
width b	mm	54		32	
height h	mm	83.5		46	
dimensional drawing					
weight (without cable)	kg	0.43		0.085	
pipe surface temperature					
min.	°C	-40			
max.	°C	+100			
ambient temperature					
min.	°C	-40			
max.	°C	+100			
temperature compensation		x			
explosion protection					
• ATEX/IECEx					
order code		GSG-NA1TS/IP68	GSK-NA1TS/IP68	GSM-NA1TS/IP68	GSP-NA1TS/IP68
pipe surface temperature (Ex)					
• min.	°C	-40			
• max.	°C	+80			
marking		CE 0637 Ex II2G II2D Ex q IIC T6...T5 Gb Ex tb IIIC T80 °C...T85 °C Db			
certification ATEX		IBExU07ATEX1168 X			
certification IECEx		IECEx IBE 08.0007X			

¹ depending on the application, typical absolute value for natural gas, nitrogen, compressed air

² shear wave transducer:
 typical values for natural gas, nitrogen, oxygen; pipe diameters for other fluids on request
 inner pipe diameter max. recommended/max. extended: in reflection arrangement and for a flow velocity of 15 m/s

³ test conditions: 3 months/2 bar (20 m)/20 °C

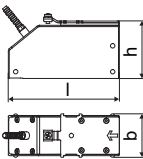
Shear wave transducers (zone 1, TS, extended temperature range)

order code		GSG-E*1TS/**	GSK-E*1TS/**
technical type		G(DL)G1E83	G(DL)K1E83
transducer frequency	MHz	0.2	0.5
fluid pressure¹			
min. extended	bar	metal pipe: 20	
min.	bar	metal pipe: 30, plastic pipe: 1	
inner pipe diameter d²			
min. extended	mm	180	60
min. recommended	mm	220	80
max. recommended	mm	900	300
max. extended	mm	1100	360
pipe wall thickness			
min.	mm	11	5
material			
housing		PPSU with stainless steel cover 304 (1.4301), ***/****/OS: 316L (1.4404)	
contact surface		PPSU	
degree of protection		IP65	
transducer cable			
type		1699	
length	m	5	
length (***/****/LC)	m	9	
dimensions			
length l	mm	129.5	
width b	mm	51	
height h	mm	67	
dimensional drawing			
weight (without cable)	kg	0.82	
pipe surface temperature			
min.	°C	-40	
max.	°C	+170	
ambient temperature			
min.	°C	-40	
max.	°C	+170	
temperature compensation		x	
explosion protection			
• ATEX/IECEX			
order code		GSG-EA1TS/**	GSK-EA1TS/**
pipe surface temperature (Ex)			
• min.	°C	-50	
• max.	°C	+155	
marking		CE 0637  II2G II2D Ex q IIC T6...T3 Gb Ex tb IIIC T80 °C...T160 °C Db	
certification ATEX		IBExU07ATEX1168 X	
certification IECEx		IECEX IBE 08.0007X	

¹ depending on the application, typical absolute value for natural gas, nitrogen, compressed air

² shear wave transducer:
 typical values for natural gas, nitrogen, oxygen; pipe diameters for other fluids on request
 inner pipe diameter max. recommended/max. extended: in reflection arrangement and for a flow velocity of 15 m/s

Shear wave transducers (zone 1, TS, extended temperature range)

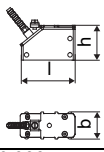
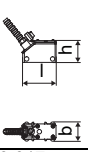
order code		GSM-E*1TS/**	GSP-E*1TS/**	GSQ-E*1TS/**
technical type		G(DL)M2E85	G(DL)P2E85	G(DL)Q2E85
transducer frequency	MHz	1	2	4
fluid pressure¹				
min. extended	bar	metal pipe: 20		
min.	bar	metal pipe: 30, plastic pipe: 1		
inner pipe diameter d²				
min. extended	mm	30	15	7
min. recommended	mm	40	20	10
max. recommended	mm	150	50	22
max. extended	mm	180	60	30
pipe wall thickness				
min.	mm	2.5	1.2	0.6
material				
housing		PI with stainless steel cover 304 (1.4301), ***-*****/OS: 316L (1.4404)		
contact surface		PI		
degree of protection		IP66		IP56
transducer cable				
type		6111		
length	m	4		3
length (***-*****/LC)	m	9		
dimensions				
length l	mm	64		40
width b	mm	32		22
height h	mm	40.5		25.5
dimensional drawing				
weight (without cable)	kg	0.066		0.017
pipe surface temperature				
min.	°C	-30		-30
max.	°C	+240 ³		+200
ambient temperature				
min.	°C	-30		-30
max.	°C	+40 +200 ⁴		+200
temperature compensation		x		
explosion protection				
• ATEX/IECEx				
order code		GSM-EA1TS/**	GSP-EA1TS/**	GSQ-EA1TS/**
pipe surface temperature (Ex)				
• min.	°C	-45		
• max.	°C	+225 ³		
marking		CE 0637 Ex II2G II2D Ex q IIC T6...T2 Gb Ex tb IIIA T80 °C...T230 °C Db		
certification ATEX		IBExU07ATEX1168 X		
certification IECEx		IECEx IBE 08.0007X		

¹ depending on the application, typical absolute value for natural gas, nitrogen, compressed air

² shear wave transducer:
 typical values for natural gas, nitrogen, oxygen; pipe diameters for other fluids on request
 inner pipe diameter max. recommended/max. extended: in reflection arrangement and for a flow velocity of 15 m/s

³ > +200 °C :
 Variofix L or Variofix C
 observe the insulation instruction
 ambient temperature max. +40 °C

⁴ pipe surface temperature max. +200 °C

Lamb wave transducers (zone 2 - FM Class I Div. 2 - nonEx, TS)

order code		GLF-N**TS/**	GLG-N**TS/**	GLH-N**TS/**	GLK-N**TS/**	GLM-N**TS/**	GLP-N**TS/**	GLQ-N**TS/**
technical type		G(RT)F1N52	G(RT)G1N52	G(RT)H1N52	G(RT)K1N52	G(RT)M1N52	G(RT)P1N52	G(RT)Q1N52
transducer frequency	MHz	0.15	0.2	0.3	0.5	1	2	4
fluid pressure¹								
min. extended	bar	metal pipe: 10			metal pipe: 10 (d > 120 mm) 3 (d < 120 mm)	metal pipe: 3 (d < 60 mm)	metal pipe: 3 (d < 35 mm)	metal pipe: 3 (d < 15 mm)
min.	bar	metal pipe: 15 plastic pipe: 1			metal pipe: 15 (d > 120 mm) 10 (d < 120 mm) plastic pipe: 1	metal pipe: 10 (d > 60 mm) 5 (d < 60 mm) plastic pipe: 1	metal pipe: 10 (d > 35 mm) 5 (d < 35 mm) plastic pipe: 1	metal pipe: 10 (d > 15 mm) 5 (d < 15 mm) plastic pipe: 1
inner pipe diameter d²								
min. extended	mm	220	180	110	60	30	15	7
min. recommended	mm	270	220	140	80	40	20	10
max. recommended	mm	1200	900	600	300	150	50	22
max. extended	mm	1600	1400	1000	360	180	60	30
pipe wall thickness								
min.	mm	15	11	8	5	2.5	1.2	0.6
max.	mm	32	24	16	10	5	3	1.2
max. extended	mm	35	-	-	-	-	-	-
material								
housing		PPSU with stainless steel cover 316Ti (1.4571)	PPSU with stainless steel cover 304 (1.4301), ***-*****/OS: 316L (1.4404)					
contact surface		PPSU						
degree of protection		IP54	IP67	IP65				
transducer cable								
type		1699						
length	m	5					4	3
length (**-*****/LC)	m	9						
dimensions								
length l	mm	163	128.5		74		42	
width b	mm	54	51		32		22	
height h	mm	91.3	67.5		40.5		25.5	
dimensional drawing								
weight (without cable)	kg	0.935	0.471		0.077		0.019	
pipe surface temperature								
min.	°C	-40						
max.	°C	+130						
ambient temperature								
min.	°C	-40						
max.	°C	+130						
temperature compensation		x						
explosion protection								
• ATEX/IECEx								
order code		GLF-NA2TS/**	GLG-NA2TS/**	GLH-NA2TS/**	GLK-NA2TS/**	GLM-NA2TS/**	GLP-NA2TS/**	GLQ-NA2TS/**
pipe surface temperature (Ex)		• min. °C -50 • max. °C gas: +165, dust: +155						
marking		CE 0637 Ex II 3G II 2D Ex nA IIC T6...T3 Gc Ex tb IIIA T80 °C...T160 °C Db						
certification ATEX		IBExU10ATEX1163 X						
certification IECEx		IECEx IBE 12.0005X						
• FM								
order code		GLF-NF2TS/**	GLG-NF2TS/**	GLH-NF2TS/**	GLK-NF2TS/**	GLM-NF2TS/**	GLP-NF2TS/**	GLQ-NF2TS/**
pipe surface temperature (Ex)		• min. °C -40 • max. °C +165						
degree of protection		IP66						
marking		NI/CI, I,II,III/Div. 2 / GP A,B,C,D,E,F,G/ Temp. Codes dwg 3860						

¹ depending on the application, typical absolute value for natural gas, nitrogen, compressed air

² Lamb wave transducer:
 typical values for natural gas, nitrogen, oxygen; pipe diameters for other fluids on request
 inner pipe diameter max. recommended: in reflection arrangement (diagonal arrangement) and for a flow velocity of 15 m/s (30 m/s)
 inner pipe diameter max. extended: in reflection arrangement (diagonal arrangement) and for a flow velocity of 12 m/s (25 m/s)

Lamb wave transducers (zone 2 - nonEx, TS, IP68)

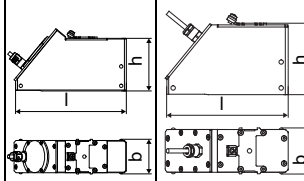
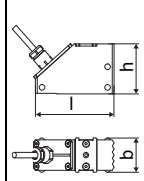
order code		GLF-N**TS/IP68	GLG-N**TS/IP68	GLH-N**TS/IP68	GLK-N**TS/IP68	GLM-N**TS/IP68	GLP-N**TS/IP68
technical type		GRF1LI8	GRG1LI8	GRH1LI8	GRK1LI8	GRM1LI8	GRP1LI8
transducer frequency	MHz	0.15	0.2	0.3	0.5	1	2
fluid pressure¹							
min. extended	bar	metal pipe: 10			metal pipe: 10 (d > 120 mm) 3 (d < 120 mm)	metal pipe: 3 (d < 60 mm)	metal pipe: 3 (d < 35 mm)
min.	bar	metal pipe: 15 plastic pipe: 1			metal pipe: 15 (d > 120 mm) 10 (d < 120 mm) plastic pipe: 1	metal pipe: 10 (d > 60 mm) 5 (d < 60 mm) plastic pipe: 1	metal pipe: 10 (d > 35 mm) 5 (d < 35 mm) plastic pipe: 1
inner pipe diameter d²							
min. extended	mm	220	180	110	60	30	15
min. recommended	mm	270	220	140	80	40	20
max. recommended	mm	1200	900	600	300	150	50
max. extended	mm	1600	1400	1000	360	180	60
pipe wall thickness							
min.	mm	15	11	8	5	2.5	1.2
max.	mm	32	24	16	10	5	3
max. extended	mm	35	-	-	-	-	-
material							
housing		PPSU with stainless steel cover 316Ti (1.4571)					
contact surface		PPSU					
degree of protection		IP68 ³					
transducer cable							
type		2550					
length	m	12					
dimensions							
length l	mm	173	143.5			73	
width b	mm	54	54			31.6	
height h	mm	91.5	83.5			46	
dimensional drawing							
weight (without cable)	kg	1.36	0.639			0.093	
pipe surface temperature							
min.	°C	-40					
max.	°C	+100					
ambient temperature							
min.	°C	-40					
max.	°C	+100					
temperature compensation		x					
explosion protection							
• ATEX/IECEX							
order code		GLF-NA2TS/IP68	GLG-NA2TS/IP68	GLH-NA2TS/IP68	GLK-NA2TS/IP68	GLM-NA2TS/IP68	GLP-NA2TS/IP68
pipe surface temperature (Ex)		-40					
• min.	°C	-40					
• max.	°C	gas: +90, dust: +80					
marking		CE 0637 Ex II3G II2D Ex nA IIC T6...T5 Gc Ex tb IIIC T80 °C...T85 °C Db					
certification ATEX		IBExU10ATEX1163 X					
certification IECEX		IECEX IBE 12.0005X					

¹ depending on the application, typical absolute value for natural gas, nitrogen, compressed air

² Lamb wave transducer:
 typical values for natural gas, nitrogen, oxygen; pipe diameters for other fluids on request
 inner pipe diameter max. recommended: in reflection arrangement (diagonal arrangement) and for a flow velocity of 15 m/s (30 m/s)
 inner pipe diameter max. extended: in reflection arrangement (diagonal arrangement) and for a flow velocity of 12 m/s (25 m/s)

³ test conditions: 3 months/2 bar (20 m)/20 °C

Lamb wave transducers (zone 1, TS)

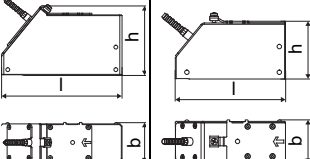
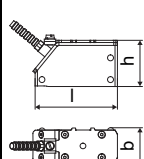
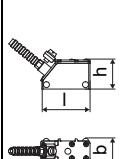
order code		GLF-N*1TS/**	GLG-N*1TS/**	GLH-N*1TS/**	GLK-N*1TS/**	GLM-N*1TS/**	GLP-N*1TS/**	GLQ-N*1TS/**
technical type		G(RT)F1N83	G(RT)G1N83	G(RT)H1N83	G(RT)K1N83	G(RT)M1N83	G(RT)P1N83	G(RT)Q1N83
transducer frequency	MHz	0.15	0.2	0.3	0.5	1	2	4
fluid pressure¹								
min. extended	bar	metal pipe: 10			metal pipe: 10 (d > 120 mm) 3 (d < 120 mm)	metal pipe: 3 (d < 60 mm)	metal pipe: 3 (d < 35 mm)	metal pipe: 3 (d < 15 mm)
min.	bar	metal pipe: 15 plastic pipe: 1			metal pipe: 15 (d > 120 mm) 10 (d < 120 mm) plastic pipe: 1	metal pipe: 10 (d > 60 mm) 5 (d < 60 mm) plastic pipe: 1	metal pipe: 10 (d > 35 mm) 5 (d < 35 mm) plastic pipe: 1	metal pipe: 10 (d > 15 mm) 5 (d < 15 mm) plastic pipe: 1
inner pipe diameter d²								
min. extended	mm	220	180	110	60	30	15	7
min. recommended	mm	270	220	140	80	40	20	10
max. recommended	mm	1200	900	600	300	150	50	22
max. extended	mm	1600	1400	1000	360	180	60	30
pipe wall thickness								
min.	mm	15	11	8	5	2.5	1.2	0.6
max.	mm	32	24	16	10	5	3	1.2
max. extended	mm	35	-	-	-	-	-	-
material								
housing		PPSU with stainless steel cover 304 (1.4301), ***-****/OS: 316L, 316Ti (1.4404, 1.4571)			PPSU with stainless steel cover 304 (1.4301), ***-****/OS: 316L (1.4404)			
contact surface		PPSU						
degree of protection		IP54			IP66		IP65	
transducer cable								
type		1699						
length	m	5			4		3	
length (**-****/LC)	m	9						
dimensions								
length l	mm	163	128.5			74		42
width b	mm	54	51			32		22
height h	mm	91.3	67.5			40.5		25.5
dimensional drawing								
weight (without cable)	kg	0.935	0.471			0.077		0.019
pipe surface temperature								
min.	°C	-40						
max.	°C	+130						
ambient temperature								
min.	°C	-40						
max.	°C	+130						
temperature compensation		x						
explosion protection								
• ATEX/IECEx								
order code		GLF-NA1TS/**	GLG-NA1TS/**	GLH-NA1TS/**	GLK-NA1TS/**	GLM-NA1TS/**	GLP-NA1TS/**	GLQ-NA1TS/**
pipe surface temperature (Ex)								
• min.	°C	-50						
• max.	°C	+155						
marking		CE 0637 (Ex) II2G II2D Ex q IIC T6...T3 Gb Ex tb IIIA T80 °C...T160 °C Db			CE 0637 (Ex) II2G II2D Ex q IIC T6...T3 Gb Ex tb IIIC T80 °C...T160 °C Db			
certification ATEX		IBExU07ATEX1168 X						
certification IECEx		IECEx IBE 08.0007X						

¹ depending on the application, typical absolute value for natural gas, nitrogen, compressed air

² Lamb wave transducer:
 typical values for natural gas, nitrogen, oxygen; pipe diameters for other fluids on request
 inner pipe diameter max. recommended: in reflection arrangement (diagonal arrangement) and for a flow velocity of 15 m/s (30 m/s)
 inner pipe diameter max. extended: in reflection arrangement (diagonal arrangement) and for a flow velocity of 12 m/s (25 m/s)

Lamb wave transducers (zone 1, TS, IP68)

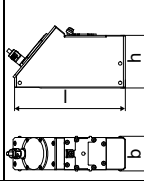
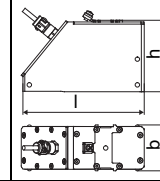
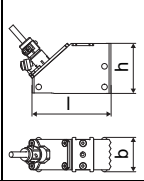
order code		GLF-N*1TS/IP68	GLG-N*1TS/IP68	GLH-N*1TS/IP68	GLK-N*1TS/IP68	GLM-N*1TS/IP68	GLP-N*1TS/IP68
technical type		GRF1LI3	G RG1LI3	GRH1LI3	GRK1LI3	GRM1LI3	GRP1LI3
transducer frequency	MHz	0.15	0.2	0.3	0.5	1	2
fluid pressure¹							
min. extended	bar	metal pipe: 10	metal pipe: 10	metal pipe: 10 (d > 120 mm) 3 (d < 120 mm)	metal pipe: 3 (d < 60 mm)	metal pipe: 3 (d < 35 mm)	
min.	bar	metal pipe: 15 plastic pipe: 1	metal pipe: 15 plastic pipe: 1	metal pipe: 15 (d > 120 mm) 10 (d < 120 mm) plastic pipe: 1	metal pipe: 10 (d > 60 mm) 5 (d < 60 mm) plastic pipe: 1	metal pipe: 10 (d > 35 mm) 5 (d < 35 mm) plastic pipe: 1	
inner pipe diameter d²							
min. extended	mm	220	180	110	60	30	15
min. recommended	mm	270	220	140	80	40	20
max. recommended	mm	1200	900	600	300	150	50
max. extended	mm	1600	1400	1000	360	180	60
pipe wall thickness							
min.	mm	15	11	8	5	2.5	1.2
max.	mm	32	24	16	10	5	3
max. extended	mm	35	-	-	-	-	-
material							
housing		PPSU with stainless steel cover 316Ti (1.4571)	PPSU with stainless steel cover 316Ti (1.4571)				
contact surface		PPSU	PPSU				
degree of protection		IP68 ³	IP68 ³				
transducer cable							
type		2550	2550				
length	m	12	12				
dimensions							
length l	mm	173	143.5				73
width b	mm	54	54				31.6
height h	mm	91.5	83.5				46
dimensional drawing							
weight (without cable)	kg	1.36	0.639				0.093
pipe surface temperature							
min.	°C	-40	-40				
max.	°C	+100	+100				
ambient temperature							
min.	°C	-40	-40				
max.	°C	+100	+100				
temperature compensation		x	x				
explosion protection							
• ATEX/IECEX							
order code		GLF-NA1TS/IP68	GLG-NA1TS/IP68	GLH-NA1TS/IP68	GLK-NA1TS/IP68	GLM-NA1TS/IP68	GLP-NA1TS/IP68
pipe surface temperature (Ex)							
• min.	°C	-40					
• max.	°C	+80					
marking		CE 0637 Ex II2G II2D Ex q IIC T6...T5 Gb Ex tb IIIC T80 °C...T85 °C Db					
certification ATEX		IBExU07ATEX1168 X					
certification IECEx		IECEx IBE 08.0007X					

¹ depending on the application, typical absolute value for natural gas, nitrogen, compressed air

² Lamb wave transducer:
 typical values for natural gas, nitrogen, oxygen; pipe diameters for other fluids on request
 inner pipe diameter max. recommended: in reflection arrangement (diagonal arrangement) and for a flow velocity of 15 m/s (30 m/s)
 inner pipe diameter max. extended: in reflection arrangement (diagonal arrangement) and for a flow velocity of 12 m/s (25 m/s)

³ test conditions: 3 months/2 bar (20 m)/20 °C

Transducer mounting fixture

Order code

1, 2	3	4	5	6	7...9	no. of character
transducer mounting fixture	transducer	measurement arrangement	size	fixation	outer pipe diameter	option
						description
VL						Variofix L
VC						Variofix C
	F					transducers with transducer frequency F
	K					transducers with transducer frequency G, H, K
	M					transducers with transducer frequency M, P
	Q					transducers with transducer frequency Q
		D				reflection arrangement or diagonal arrangement
		R				reflection arrangement
			S			small
			M			medium
			L			large
				B	bolts	
				S	tension straps	
				W	welding	
				N	without fixation	
					002	10...20 mm
					004	20...40 mm
					T36	40...360 mm
					013	10...130 mm
					036	130...360 mm
					092	360...920 mm
					200	920...2000 mm
						IP68 for transducers with degree of protection IP68
						OS housing with stainless steel 316
						Z special design

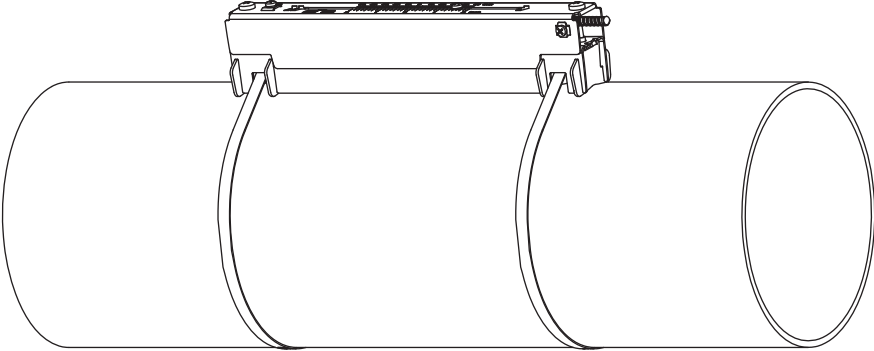
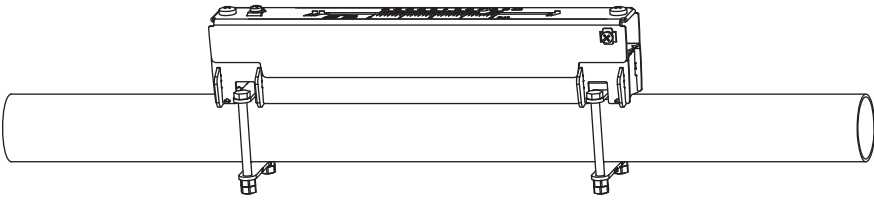
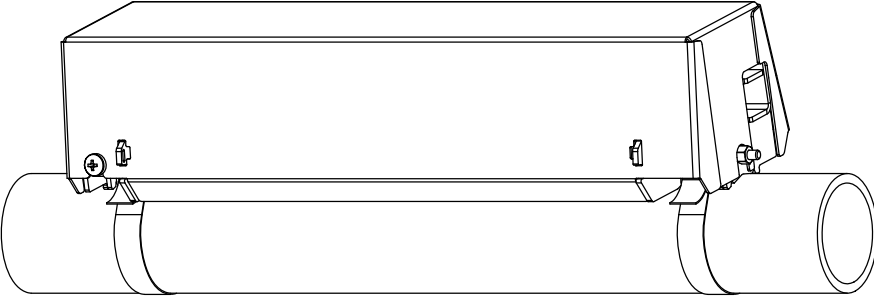
<p>Variofix L (VLK, VLM, VLQ)</p> 	<p>material: stainless steel 304 (1.4301), 301 (1.4310), 410 (1.4006) option OS: 316Ti (1.4571), 316L (1.4404), 17-7PH (1.4568) inner length: VLK: 348 mm, option IP68: 368 mm VLM: 234 mm VLQ: 176 mm dimensions: VLK: 423 x 90 x 93 mm option IP68: 443 x 94 x 105 mm VLM: 309 x 57 x 63 mm VLQ: 247 x 43 x 47 mm</p>
<p>Variofix L with bolt mounting plates (VL**B)</p> 	<p>material: stainless steel 304 (1.4301), 301 (1.4310), 410 (1.4006) option OS: 316Ti (1.4571), 316L (1.4404), 17-7PH (1.4568) inner length: VLM: 234 mm VLQ: 176 mm dimensions: VLM: 309 x 57 x 63 mm VLQ: 247 x 43 x 47 mm outer pipe diameter: max. 48 mm</p>
<p>Variofix C (VC)</p> 	<p>material: stainless steel 316Ti (1.4571) inner length: VCF-*L, VCK-*L: 500 mm VCF-*S, VCK-*S: 350 mm VCM: 400 mm VCQ: 250 mm dimensions: VCF-*L, VCK-*L: 560 x 126 x 125 mm VCF-*S, VCK-*S: 410 x 126 x 125 mm VCM: 460 x 96 x 82 mm VCQ: 310 x 85 x 71 mm</p>

Coupling materials for transducers

	normal temperature range (4th character of transducer order code = N)		extended temperature range (4th character of transducer order code = E)		
	< 100 °C	< 170 °C	< 150 °C	< 200 °C	200...240 °C
< 24 h	coupling compound type N or coupling foil type VT	coupling compound type E or coupling foil type VT	coupling compound type E or coupling foil type VT	coupling compound type E or H or coupling foil type VT	coupling foil type TF
long time measurement	coupling foil type VT	coupling foil type VT	coupling foil type VT	coupling foil type VT	coupling foil type TF

type VT: fluid temperature 200 °C: min. 2 years

Technical data

type	ambient temperature °C
coupling compound type N	-30...+130
coupling compound type E	-30...+200
coupling compound type H	-30...+250
coupling foil type VT	-10...+200
coupling foil type TF	200...240

Damping material (optional)

Damping material will be used for the gas measurement to reduce acoustic noise influences on the measurement.

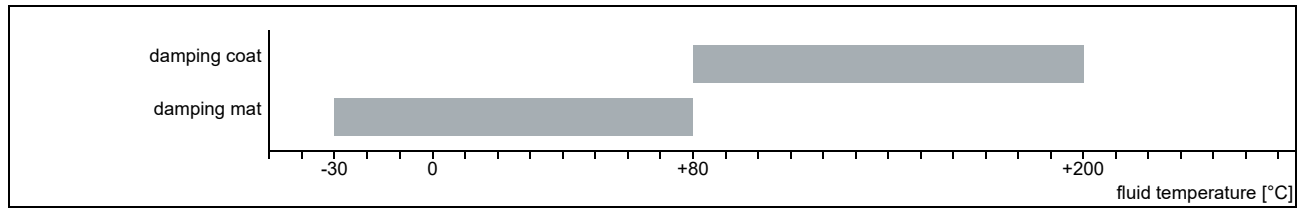

Damping mats

transducer damping mat

Transducer damping mats will be installed below the transducers.

pipe damping mat

Pipe damping mats will be installed if the sound propagation is disturbed at reflection points (e.g. flange, weld). Depending on the noise, the pipe damping mats will be installed at one or both sides of the transducer damping mat. If the local conditions are unknown, pipe damping mats should be installed.

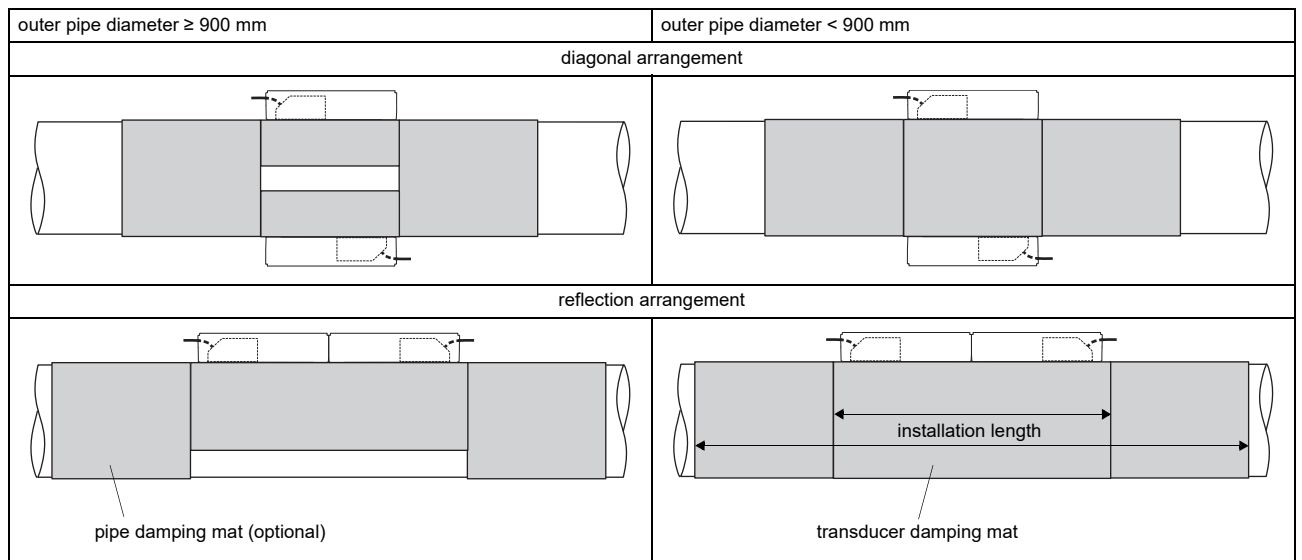

Technical data

type		E30R4	E30R3
order code		ACC-PE-GNNN-/DPD2	ACC-PE-GNNN-/DPD1
width	mm	225	50
thickness	mm	0.7	
length (per roll)	m	10	
weight	kg/m ²	1.015	
ambient temperature	°C	-30...+80	
properties		self-adhesive	

Dimensioning

transducer		damping mat							
transducer mounting fixture	order code	type	number of layers	transducer damping mat			transducer damping mat + 2x pipe damping mat		
				max. installation length [mm]	number of rolls ¹		max. installation length [mm]	number of rolls ¹	
					standard ²	extended ²		standard	extended
VarioFix L									
VLK	GLG	E30R4	3	890	4	4	1830	9	12
	GSG		3		4	4		9	10
	GLH		2		2	3		4	7
	GLK		1		1	1		2	2
	GSK		1		1	1		2	2
VLK-**-****/IP68	GLG	E30R4	3	930	5	5	1910	10	13
	GSG		3		5	5		10	11
	GLH		2		2	3		5	7
	GLK		1		1	1		2	2
	GSK		1		1	1		2	2
VLM	GLM	E30R3	1	660	1	1	1360	2	2
	GSM		1		1	1		2	2
	GLP		1		1	1		1	1
	GSP		1		1	1		1	1
VLQ	GLQ	E30R3	1	540	1	1	1120	1	1
	GSQ		1		1	1		1	1
Variofix C									
VCF-*L-****/IP68	GLF	E30R4	3	1160	6	6	2360	13	15
VCK-*L VCK-*L-****/IP68	GLG	E30R4	3	1160	6	6	2360	11	14
	GSG		3		6	6		11	12
	GLH		2		3	4		5	8
	GLK		1		1	1		2	2
	GSK		1		1	1		2	2
VCF-*S-****/IP68	GLF	E30R4	3	860	4	4	1760	9	10
VCK-*S VCK-*S-****/IP68	GLG	E30R4	3	860	4	4	1760	7	9
	GSG		3		4	4		7	8
	GLH		2		2	3		4	5
	GLK		1		1	1		1	1
	GSK		1		1	1		1	1
VCM	GLM	E30R3	1	960	2	2	1960	3	3
	GSM		1		2	2		3	3
	GLP		1		1	1		1	1
	GSP		1		1	1		1	1
VCQ	GLQ	E30R3	1	660	1	1	1360	1	1
	GSQ		1		1	1		1	1

¹ calculation on the base of:
 max. installation length (installation of one transducer mounting fixture per transducer in reflection arrangement) and
 max. recommended pipe diameter (standard) or max. extended pipe diameter (extended)

² calculation of the number of rolls when both transducers are mounted in one transducer mounting fixture (reflection arrangement) or in diagonal arrangement: number of rolls/2 and round up to the nearest integer

Damping coat

For high temperatures it is recommended to apply the damping coat onto the pipe.

Technical data

order code	ACC-PE-GNNN-/DPL1
material	multipolymeric matrix/inorganic ceramic coating
packing drum	1
properties	heat resistant, inert

Observe installation instructions (TI_DampingCoat).

Dimensioning

transducer frequency	number of packing drums		
	outer pipe diameter		
	≤300 mm	≤500 mm	≤700 mm
F	3	4	5
G	2	3	4
H	2	2	3
K	2	2	-
M	2	-	-
P	1	-	-
Q	1	-	-

Connection systems

connection system TS		
connection with extension cable	direct connection	transducers technical type
<p>JB01</p>		<p>****8*</p>
<p>JB01, JBP2, JBP3</p>		<p>****L*</p>
<p>JB02, JB03, JB04</p>		<p>****52</p>

Cable

transducer cable				
type		1699	2550	6111
weight	kg/m	0.094	0.035	0.092
ambient temperature	°C	-55...+200	-40...+100	-100...+225
properties			longitudinal watertight	
cable jacket				
material		PTFE	PUR	PFA
outer diameter	mm	2.9	5.2 ±0.2	2.7
thickness	mm	0.3	0.9	0.5
colour		brown	grey	white
shield		x	x	x
sheath				
material		stainless steel 304 (1.4301) option OS: 316Ti (1.4571)	-	stainless steel 304 (1.4301) option OS: 316Ti (1.4571)
outer diameter	mm	8	-	8

extension cable				
type		2615	5245	
order code		ACC-PE- GNNN-/EXEXXX	ACC-PE- GNNN-/EXA1XXX	
weight	kg/m	0.18	0.38	
ambient temperature	°C	-30...+70	-30...+70	
properties		halogen free fire propagation test according to IEC 60332-1 combustion test according to IEC 60754-2	halogen free fire propagation test according to IEC 60332-1 combustion test according to IEC 60754-2	
cable jacket				
material		PUR	PUR	
outer diameter	mm	max. 12	max. 12	
thickness	mm	2	2	
colour		black	black	
shield		x	x	
sheath				
material		-	steel wire braid with copolymer sheath	
outer diameter	mm	-	max. 15.5	

XXX - cable length in m

Cable length

transducer frequency		F, G, H, K		M, P		Q		S	
connection system TS									
transducers technical type		x		x		x		x	
*(DR)**8*	m	5	≤ 300	4	≤ 300	3	≤ 90	-	-
option LC: *(LT)**8*	m	9	≤ 300	9	≤ 300	9	≤ 90	-	-
*(DR)**5*	m	5	≤ 300	4	≤ 300	3	≤ 90	2	≤ 40
option LC: *(LT)**5*	m	9	≤ 300	9	≤ 300	9	≤ 90	-	-
option IP68: ****L*	m	12	≤ 300	12	≤ 300	-	-	-	-

x - transducer cable length

l - max. length of extension cable (depending on the application)

Junction box

Technical data

JB01S4E3M, JBP2, JBP3			
weight	kg	1.2 kg	
fixation		wall mounting optional: 2" pipe mounting	
material			
housing		stainless steel 316L (1.4404)	
gasket		silicone	
degree of protection		IP67	
ambient temperature			
min.	°C	-40	
max.	°C	+80	
explosion protection			
• ATEX/IECEX (zone 1)			
junction box		JB01S4E3M	
marking		CE 0637 Ex II2G II2D Ex eb mb IIC T6...T4 Gb Ex tb IIIC T100 °C Db Ta -40...+70/80 °C	
certification ATEX		IBExU06ATEX1161	
certification IECEx		IECEX IBE 08.0006	
type of protection		gas: increased safety decoupled network: encapsulation dust: protection by enclosure	
• ATEX (zone 2)			
junction box		JBP2	
marking		CE Ex II3G Ex nA IIC (T6)...T4 Gc II3D Ex tc IIIC T 100 °C Dc Ta -40...+(70)80 °C	
Connection			
Transducers			
terminal strip	terminal	connection	transducer
KL1	V	signal	↑
	VS	internal shield	
	RS	internal shield	⤴
	R	signal	
Extension cable			
terminal strip	terminal	connection	
KL2	TV	signal	
	TVS	internal shield	
	TRS	internal shield	
	TR	signal	
JB02, JB03, JB04			
weight	kg	1.2 kg	
fixation		wall mounting optional: 2" pipe mounting	
material			
housing		stainless steel 316L (1.4404)	
gasket		silicone	
degree of protection		IP67	
ambient temperature			
min.	°C	-40	
max.	°C	+80	
explosion protection			
• ATEX			
junction box		JB02	
marking		CE Ex II3G Ex nA IIC (T6)...T4 Gc II3D Ex tc IIIC T 100 °C Dc Ta -40...+(70)80 °C	
• FM			
junction box		JB04	
marking		NI/Cl. I,II,III/Div. 2 / GP A,B,C,D,E,F,G/ T6 Ta = -40...+60 °C	
Connection			
Transducers			
terminal strip	terminal	connection	transducer
	XV	SMB connector	↑
	XR	SMB connector	
Extension cable			
terminal strip	terminal	connection	
KL2	TV	signal	
	TVS	internal shield	
	TRS	internal shield	
	TR	signal	

Dimensions

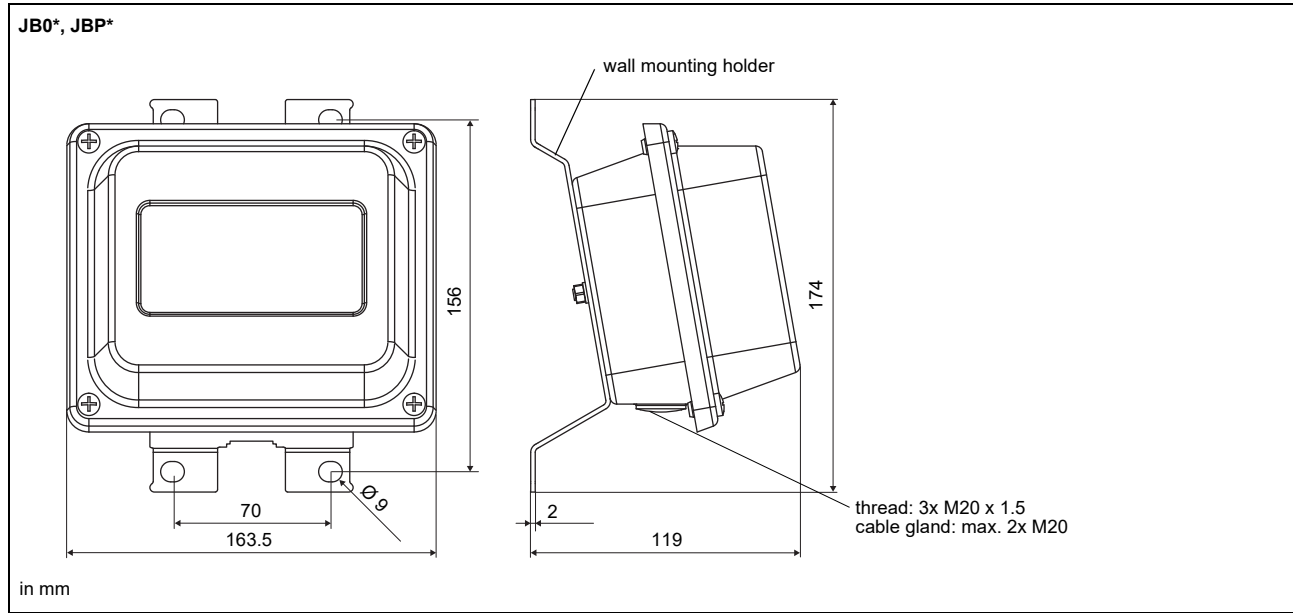









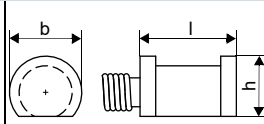
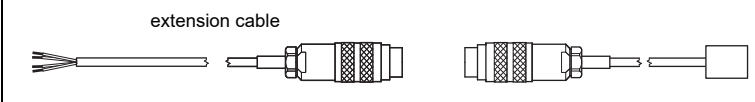
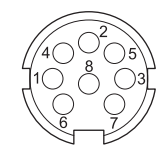
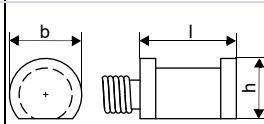
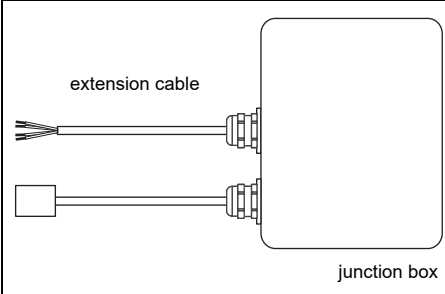
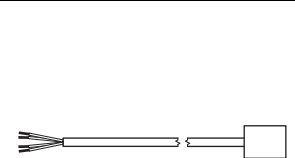

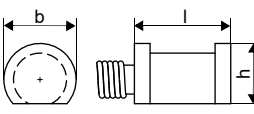
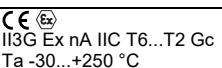
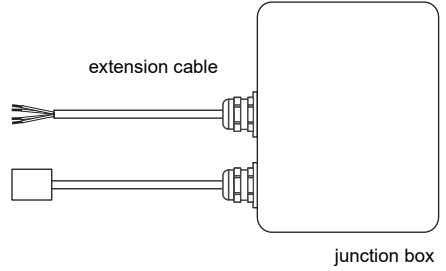
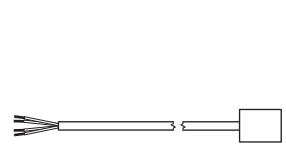
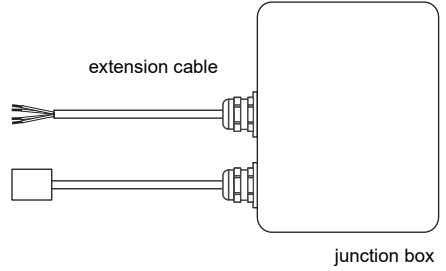
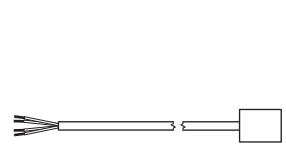
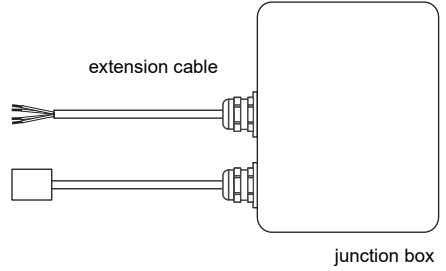
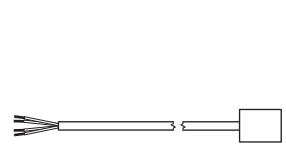

2" pipe mounting kit











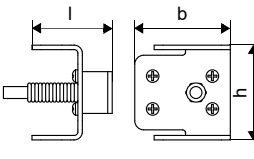
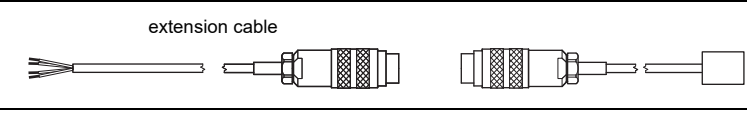

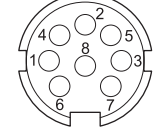



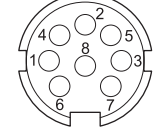



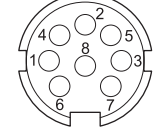





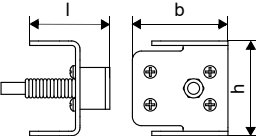
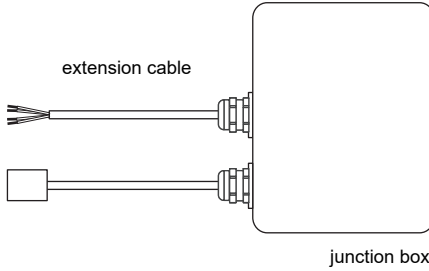
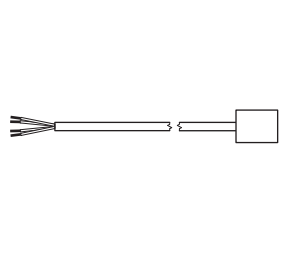

Clamp-on temperature probe (optional)

Technical data

PT12N			
design		clamp-on with connector	
type		Pt100	
connection		4-wire	
measuring range	°C	-30...+250	
accuracy T		$\pm(0.15 \text{ } ^\circ\text{C} + 2 \cdot 10^{-3} \cdot T \text{ [}^\circ\text{C]})$ class A	
accuracy ΔT (2x Pt matched according to EN 1434-1)		$\leq 0.1 \text{ K}$ ($3 \text{ K} < \Delta T < 6 \text{ K}$), more corresponding to EN 1434-1	
response time	s	50 (t_{50} , $T_1 = 25 \text{ } ^\circ\text{C}$, $T_2 = 60 \text{ } ^\circ\text{C}$)	
housing		aluminum	
degree of protection		IP54	
dimensions			
length l	mm	20	
width b	mm	15	
height h	mm	13	
dimensional drawing			
weight	kg	0.25 (without connector)	
accessories			
thermal conductivity paste 200 °C		x	
thermal conductivity foil 250 °C		x	
Connection system			
direct connection/connection with extension cable			
			
Connection			
	temperature probe	extension cable	connector
	red	grey	2
	red/blue	red	6
	white/blue	blue	1
	white	white	7
			
Cable			
	temperature probe	extension cable	
type	4 x 0.22 mm ²	LIYCY 8 x 0.14 mm ²	
standard length	m	3	
max. length	m	-	
ambient temperature °C	-90...+200	-25...+80	
min. bend radius	mm	27	
cable jacket			
material	PFA	PVC	
outer diameter	mm	3.8 ±0.15	
colour	black	grey	
PT12N			
design		clamp-on	
type		Pt100	
connection		4-wire	
measuring range	°C	-30...+250	
accuracy T		$\pm(0.15 \text{ } ^\circ\text{C} + 2 \cdot 10^{-3} \cdot T \text{ [}^\circ\text{C]})$ class A	
accuracy ΔT (2x Pt matched according to EN 1434-1)		$\leq 0.1 \text{ K}$ ($3 \text{ K} < \Delta T < 6 \text{ K}$), more corresponding to EN 1434-1	
response time	s	50 (t_{50} , $T_1 = 25 \text{ } ^\circ\text{C}$, $T_2 = 60 \text{ } ^\circ\text{C}$)	
housing		aluminum	
degree of protection		IP54	
dimensions			
length l	mm	20	
width b	mm	15	
height h	mm	13	
dimensional drawing			
weight	kg	0.25	
accessories			
thermal conductivity foil 250 °C		x	
Connection system			
connection with extension cable		direct connection	
			
Connection			
	temperature probe		
	red		
	red/blue		
	white/blue		
	white		
Cable			
	temperature probe	extension cable	
type	4 x 0.22 mm ²	LIYCY 8 x 0.14 mm ²	
max. length	m	-	
ambient temperature °C	-90...+200	-25...+80	
min. bend radius	mm	27	
cable jacket			
material	PFA	PVC	
outer diameter	mm	3.8 ±0.15	
colour	black	grey	

PT12N																															
design	clamp-on ATEX																														
type	Pt100																														
connection	4-wire																														
measuring range	°C -30...+250																														
accuracy T	$\pm(0.15 \text{ °C} + 2 \cdot 10^{-3} \cdot T \text{ [°C] })$ class A																														
accuracy ΔT (2x Pt matched according to EN 1434-1)	$\leq 0.1 \text{ K}$ ($3 \text{ K} < \Delta T < 6 \text{ K}$), more corresponding to EN 1434-1																														
response time	s 50																														
housing	aluminum																														
degree of protection	IP67																														
dimensions																															
length l	mm 20																														
width b	mm 15																														
height h	mm 13																														
dimensional drawing																															
weight	kg 0.25																														
accessories																															
thermal conductivity foil 250 °C	x																														
explosion protection																															
• ATEX																															
marking																															
Connection system																															
<table border="1"> <thead> <tr> <th>connection with extension cable</th> <th>direct connection</th> </tr> </thead> <tbody> <tr> <td></td> <td></td> </tr> </tbody> </table>		connection with extension cable	direct connection																												
connection with extension cable	direct connection																														
																															
Connection																															
<table border="1"> <thead> <tr> <th></th> <th>temperature probe</th> </tr> </thead> <tbody> <tr> <td></td> <td>red</td> </tr> <tr> <td></td> <td>red/blue</td> </tr> <tr> <td></td> <td>white</td> </tr> <tr> <td></td> <td>white/blue</td> </tr> </tbody> </table>			temperature probe		red		red/blue		white		white/blue																				
	temperature probe																														
	red																														
	red/blue																														
	white																														
	white/blue																														
Cable																															
<table border="1"> <thead> <tr> <th></th> <th>temperature probe</th> <th>extension cable</th> </tr> </thead> <tbody> <tr> <td>type</td> <td>4 x 0.25 mm²</td> <td>LIYCY 8 x 0.14 mm²</td> </tr> <tr> <td>standard length</td> <td>m 3</td> <td>5/10/25</td> </tr> <tr> <td>max. length</td> <td>m -</td> <td>200</td> </tr> <tr> <td>ambient temperature</td> <td>°C -25...+80</td> <td></td> </tr> <tr> <td>min. bend radius</td> <td>mm</td> <td>68</td> </tr> <tr> <td colspan="3">cable jacket</td> </tr> <tr> <td>material</td> <td>PTFE</td> <td>PVC</td> </tr> <tr> <td>outer diameter</td> <td>mm</td> <td>4.8 ±2</td> </tr> <tr> <td>colour</td> <td>black</td> <td>grey</td> </tr> </tbody> </table>			temperature probe	extension cable	type	4 x 0.25 mm ²	LIYCY 8 x 0.14 mm ²	standard length	m 3	5/10/25	max. length	m -	200	ambient temperature	°C -25...+80		min. bend radius	mm	68	cable jacket			material	PTFE	PVC	outer diameter	mm	4.8 ±2	colour	black	grey
	temperature probe	extension cable																													
type	4 x 0.25 mm ²	LIYCY 8 x 0.14 mm ²																													
standard length	m 3	5/10/25																													
max. length	m -	200																													
ambient temperature	°C -25...+80																														
min. bend radius	mm	68																													
cable jacket																															
material	PTFE	PVC																													
outer diameter	mm	4.8 ±2																													
colour	black	grey																													

PT12F																															
design	clamp-on short response time, with connector																														
type	Pt100																														
connection	4-wire																														
measuring range	°C -50...+250																														
accuracy T	$\pm(0.15 \text{ °C} + 2 \cdot 10^{-3} \cdot T \text{ [°C] })$ class A																														
accuracy ΔT (2x Pt matched according to EN 1434-1)	$\leq 0.1 \text{ K}$ ($3 \text{ K} < \Delta T < 6 \text{ K}$), more corresponding to EN 1434-1																														
response time	s 8 (t ₅₀ , T ₁ = 25 °C, T ₂ = 60 °C)																														
housing	PEEK, stainless steel 304 (1.4301), copper																														
degree of protection	IP54																														
dimensions																															
length l	mm 14																														
width b	mm 30																														
height h	mm 27																														
dimensional drawing																															
weight	kg 0.32 (without connector)																														
accessories																															
thermal conductivity paste 200 °C	x																														
thermal conductivity foil 250 °C	x																														
plastic protection plate, insulation foam	x																														
Connection system																															
																															
Connection																															
<table border="1"> <thead> <tr> <th rowspan="2"></th> <th rowspan="2">temperature probe</th> <th rowspan="2">extension cable</th> <th colspan="2">connector</th> </tr> <tr> <th>pin</th> <th></th> </tr> </thead> <tbody> <tr> <td></td> <td>red</td> <td>grey</td> <td>2</td> <td rowspan="5">  </td> </tr> <tr> <td></td> <td>red/blue</td> <td>red</td> <td>6</td> </tr> <tr> <td></td> <td>white/blue</td> <td>blue</td> <td>1</td> </tr> <tr> <td></td> <td>white</td> <td>white</td> <td>7</td> </tr> </tbody> </table>			temperature probe	extension cable	connector		pin			red	grey	2			red/blue	red	6		white/blue	blue	1		white	white	7						
	temperature probe				extension cable	connector																									
		pin																													
	red	grey	2																												
	red/blue	red	6																												
	white/blue	blue	1																												
	white	white	7																												
Cable																															
<table border="1"> <thead> <tr> <th></th> <th>temperature probe</th> <th>extension cable</th> </tr> </thead> <tbody> <tr> <td>type</td> <td>4 x 0.22 mm²</td> <td>LIYCY 8 x 0.14 mm²</td> </tr> <tr> <td>standard length</td> <td>m 3</td> <td>5/10/25</td> </tr> <tr> <td>max. length</td> <td>m -</td> <td>200</td> </tr> <tr> <td>ambient temperature</td> <td>°C -90...+200</td> <td>-25...+80</td> </tr> <tr> <td>min. bend radius</td> <td>mm 27</td> <td>68</td> </tr> <tr> <td colspan="3">cable jacket</td> </tr> <tr> <td>material</td> <td>PFA</td> <td>PVC</td> </tr> <tr> <td>outer diameter</td> <td>mm 3.8 ±0.15</td> <td>4.8 ±2</td> </tr> <tr> <td>colour</td> <td>black</td> <td>grey</td> </tr> </tbody> </table>			temperature probe	extension cable	type	4 x 0.22 mm ²	LIYCY 8 x 0.14 mm ²	standard length	m 3	5/10/25	max. length	m -	200	ambient temperature	°C -90...+200	-25...+80	min. bend radius	mm 27	68	cable jacket			material	PFA	PVC	outer diameter	mm 3.8 ±0.15	4.8 ±2	colour	black	grey
	temperature probe	extension cable																													
type	4 x 0.22 mm ²	LIYCY 8 x 0.14 mm ²																													
standard length	m 3	5/10/25																													
max. length	m -	200																													
ambient temperature	°C -90...+200	-25...+80																													
min. bend radius	mm 27	68																													
cable jacket																															
material	PFA	PVC																													
outer diameter	mm 3.8 ±0.15	4.8 ±2																													
colour	black	grey																													

PT12F																																
type		Pt100																														
connection		4-wire																														
measuring range	°C	-50...+250																														
accuracy T		$\pm(0.15 \text{ °C} + 2 \cdot 10^{-3} \cdot T \text{ [°C] })$ class A																														
response time	s	8 (t50, T1 = 25 °C, T2 = 60 °C)																														
housing		PEEK, stainless steel 304 (1.4301), copper																														
degree of protection		IP54																														
dimensions																																
length l	mm	14																														
width b	mm	30																														
height h	mm	27																														
dimensional drawing																																
weight	kg	0.32																														
accessories																																
thermal conductivity paste 200 °C		x																														
thermal conductivity foil 250 °C		x																														
plastic protection plate, insulation foam		x																														
Connection system																																
connection with extension cable		direct connection																														
																																
Connection																																
<table border="1"> <thead> <tr> <th></th> <th>temperature probe</th> </tr> </thead> <tbody> <tr> <td></td> <td>red</td> </tr> <tr> <td></td> <td>red/blue</td> </tr> <tr> <td></td> <td>white/blue</td> </tr> <tr> <td></td> <td>white</td> </tr> </tbody> </table>				temperature probe		red		red/blue		white/blue		white																				
	temperature probe																															
	red																															
	red/blue																															
	white/blue																															
	white																															
Cable																																
<table border="1"> <thead> <tr> <th></th> <th>temperature probe</th> <th>extension cable</th> </tr> </thead> <tbody> <tr> <td>type</td> <td>4 x 0.22 mm²</td> <td>LIYCY 8 x 0.14 mm²</td> </tr> <tr> <td>standard length</td> <td>m</td> <td>3</td> </tr> <tr> <td>max. length</td> <td>m</td> <td>-</td> </tr> <tr> <td>ambient temperature</td> <td>°C</td> <td>-90...+200</td> </tr> <tr> <td>min. bend radius</td> <td>mm</td> <td>27</td> </tr> <tr> <td colspan="3">cable jacket</td> </tr> <tr> <td>material</td> <td>PFA</td> <td>PVC</td> </tr> <tr> <td>outer diameter</td> <td>mm</td> <td>3.8 ±0.15</td> </tr> <tr> <td>colour</td> <td>black</td> <td>grey</td> </tr> </tbody> </table>				temperature probe	extension cable	type	4 x 0.22 mm ²	LIYCY 8 x 0.14 mm ²	standard length	m	3	max. length	m	-	ambient temperature	°C	-90...+200	min. bend radius	mm	27	cable jacket			material	PFA	PVC	outer diameter	mm	3.8 ±0.15	colour	black	grey
	temperature probe	extension cable																														
type	4 x 0.22 mm ²	LIYCY 8 x 0.14 mm ²																														
standard length	m	3																														
max. length	m	-																														
ambient temperature	°C	-90...+200																														
min. bend radius	mm	27																														
cable jacket																																
material	PFA	PVC																														
outer diameter	mm	3.8 ±0.15																														
colour	black	grey																														

Fixation

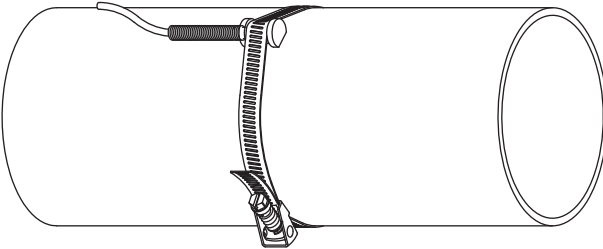
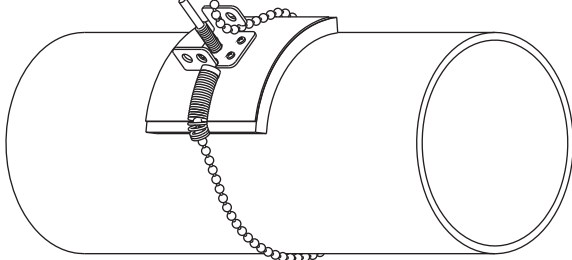
<p>tension strap PT12N</p> 	<p>material: stainless steel 301 (1.4310), 410 (1.4006) thermal insulation necessary</p>
<p>ball chain PT12F</p> 	<p>material: stainless steel 316L (1.4404) length: 1 m</p>

Junction box

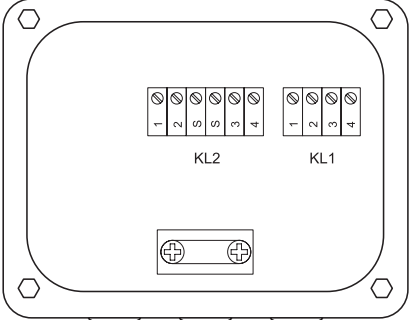
JBT2, JBT3																									
order code	<ul style="list-style-type: none"> • JBT2: ACC-PE-GNNN-/JB4 • JBT3: ACC-PE-GNNN-/JB6 																								
weight	kg 1.2 kg																								
fixation	wall mounting optional: 2" pipe mounting																								
material																									
housing	stainless steel 316L (1.4404)																								
gasket	silicone																								
degree of protection	IP67																								
ambient temperature																									
min.	°C -40																								
max.	°C +80																								
explosion protection																									
• ATEX																									
junction box marking	JBT2																								
	 II3G Ex nA IIC (T6)...T4 Gc II3D Ex tc IIIC T 100 °C Dc Ta -40...+(70)80 °C																								
<div style="display: flex; justify-content: space-between;"> <div style="width: 45%;"> <p>Connection</p>  </div> <div style="width: 45%;"> <p>Temperature probe</p> <table border="1"> <thead> <tr> <th>terminal strip</th> <th>terminal</th> <th>connection</th> </tr> </thead> <tbody> <tr> <td rowspan="4">KL1</td> <td>1</td> <td>red</td> </tr> <tr> <td>2</td> <td>red/blue</td> </tr> <tr> <td>3</td> <td>white</td> </tr> <tr> <td>4</td> <td>white/blue</td> </tr> </tbody> </table> <p>Extension cable</p> <table border="1"> <thead> <tr> <th>terminal strip</th> <th>terminal</th> <th>connection</th> </tr> </thead> <tbody> <tr> <td rowspan="4">KL2</td> <td>1</td> <td>red</td> </tr> <tr> <td>2</td> <td>grey</td> </tr> <tr> <td>3</td> <td>white</td> </tr> <tr> <td>4</td> <td>blue</td> </tr> </tbody> </table> </div> </div>		terminal strip	terminal	connection	KL1	1	red	2	red/blue	3	white	4	white/blue	terminal strip	terminal	connection	KL2	1	red	2	grey	3	white	4	blue
terminal strip	terminal	connection																							
KL1	1	red																							
	2	red/blue																							
	3	white																							
	4	white/blue																							
terminal strip	terminal	connection																							
KL2	1	red																							
	2	grey																							
	3	white																							
	4	blue																							

Dimensions

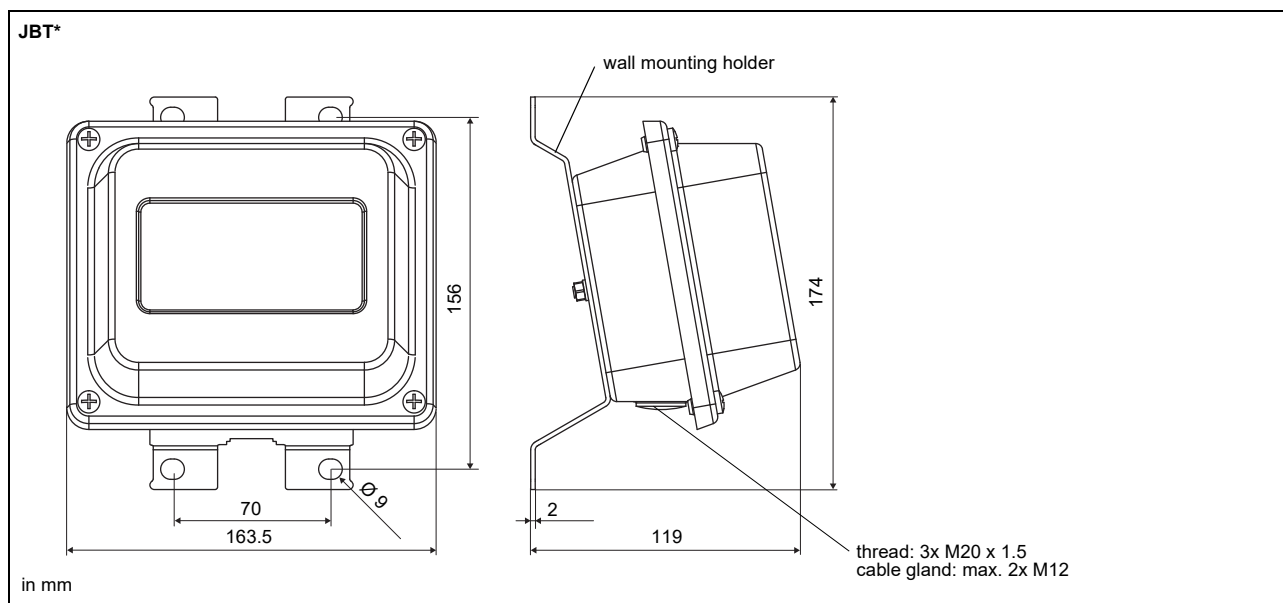

2" pipe mounting kit

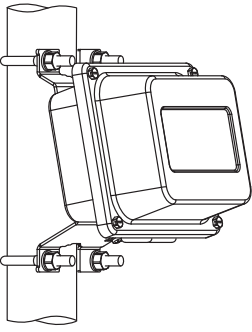
<p>JB**</p> 	<p>order code: ACC-PE-GNNN-JBPMK4</p>
---	---

FLEXIM GmbH
Boxberger Str. 4
12681 Berlin
Germany
Tel.: +49 (30) 93 66 76 60
Fax: +49 (30) 93 66 76 80
internet: www.flexim.com
e-mail: info@flexim.com

Subject to change without prior notice.
Errors excepted.

FLUXUS is a registered trademark of FLEXIM GmbH.

Copyright (©) FLEXIM GmbH 2021